



Absolutely The Best Crane Mats In The World.

This document is stored and available in the Raptor Tech Technical Document Repository.

To help our customers understand certain critical data points that factor into purchasing crane mats, Raptor Tech maintains a repository of technical documents with data from all major crane manufacturers.

You can visit Raptor Tech's repository to get crane specifications and technical details for crane models in addition to this model at:

<https://library.steelcranemats.com>

Thank You for Visiting the [SteelCraneMats.com](https://library.steelcranemats.com) Technical Specifications Document Repository.

RT530E-2 Product Guide

ASME B30.5
Imperial 85%



Features

- 30 t (30 USt) capacity
- 8,8 m – 29 m (29 ft – 95 ft) four-section full-power boom
- 7,9 m – 13,7 m (26 ft – 45 ft) offsettable telescopic swingaway extension
- Intuitive, user friendly controls with electronic joysticks and operator customizable function speeds
- Full frame decking
- 122 kW (164 hp) Tier 4F Cummins diesel engine

GROVE RT530E-2

Grove design and engineering expertise have been developed through years of manufacturing an outstanding line of performance-proven, rough-terrain cranes. The RT530E-2 builds upon this tradition with exceptional mobility and fast set-up on any job-site.

Features

> Boom shape

The RT530E-2 incorporates a rectangular boom shape made from 100 ksi steel, which eliminates weight and maximizes structural capacities.



> Crane Control System (CCS)

The Crane Control System (CCS) offers a user friendly interface, two full graphic displays mounted vertically for easier viewing and a jog dial for easier navigation and data input. The system allows the electronic controllers to be reprogrammed by the operator for specific speed and reaction.



> Cab

The Full Vision cab with tilt-telescoping steering wheel, single or dual-axis controllers, hot water heat and air conditioning provide all day comfort for the operator.



> Tip height

Maximum tip height of 44,5 m (146 ft) with 13,7 m (45 ft) telescopic extension.



> CraneSTAR is an exclusive and innovative crane asset management system

that helps improve your profitability and reduce costs by remotely monitoring critical crane data. Visit www.cranestar.com for more information.

Jobsite benefits

> Exceptional maneuverability

Maneuvering around the job site is easier with Grove rough-terrain cranes. Four-wheel drive combined with four modes of steering (front only, rear only, crab and coordinated) allows operators to get closer to the lift regardless of congested areas or adverse ground conditions. All modes are controlled through steering wheel and rocker switches, so there's no need for operators to stop and align the wheels.



> Jobsite flexibility means more lifts for greater profitability

Grove rough-terrain cranes can be reconfigured to fit numerous lifting applications, giving you more lifting versatility. That provides you with the potential to win more jobs for greater profitability and return on investment.

> Innovation drives enhanced operation and efficiency

Grove utilizes the latest technology to provide the highest work efficiency and safety — all while meeting today's strict environmental standards. Our innovations ensure reliable crane performance along with operator productivity and comfort.



Manitowoc Crane Care when you need it.
The assurance of the world's most advanced crane service and support to get you back to work fast.



Manitowoc Finance helps you get right to work generating profits for your business.
Financial tools that help you capitalize on opportunity with solutions that fit your needs.

Dimensions and weights

Dimensions												
	Tire size	A	B	C	D	E	F	G	H	J	K	L
Two-wheel steer	20.5 x 25	12 838 mm (505 in)	12 428 mm (489)	10 899 mm (429 in)	10 236 mm (403 in)	10 007 mm (394 in)	8138 mm (320 in)	7021 mm (276 in)	2055 mm (81 in)	25.0°	22.5°	2606 mm (103 in)
	16.0 x 25	12 838 mm (505 in)	12 428 mm (489)	10 899 mm (429 in)	10 185 mm (401 in)	9981 mm (393 in)	8138 mm (320 in)	7021 mm (276 in)	2093 mm (82 in)	26.0°	23.5°	2536 mm (100 in)
Four-wheel steer	20.5 x 25	8967 mm (329 in)	8630 mm (339)	6732 mm (265 in)	6061 mm (239 in)	5832 mm (230 in)	4000 mm (157 in)	3498 mm (137 in)	2055 mm (81 in)	25.0°	22.5°	2606 mm (103 in)
	16.0 x 25	8967 mm (329 in)	8630 mm (339)	6732 mm (265 in)	6010 mm (237 in)	5806 mm (229 in)	4000 mm (157 in)	3498 mm (137 in)	2093 mm (82 in)	26.0°	23.5°	2536 mm (100 in)

Notes:
 1. All dimensions are for reference only
 2. *Boo*
 3. *Dir*
Add

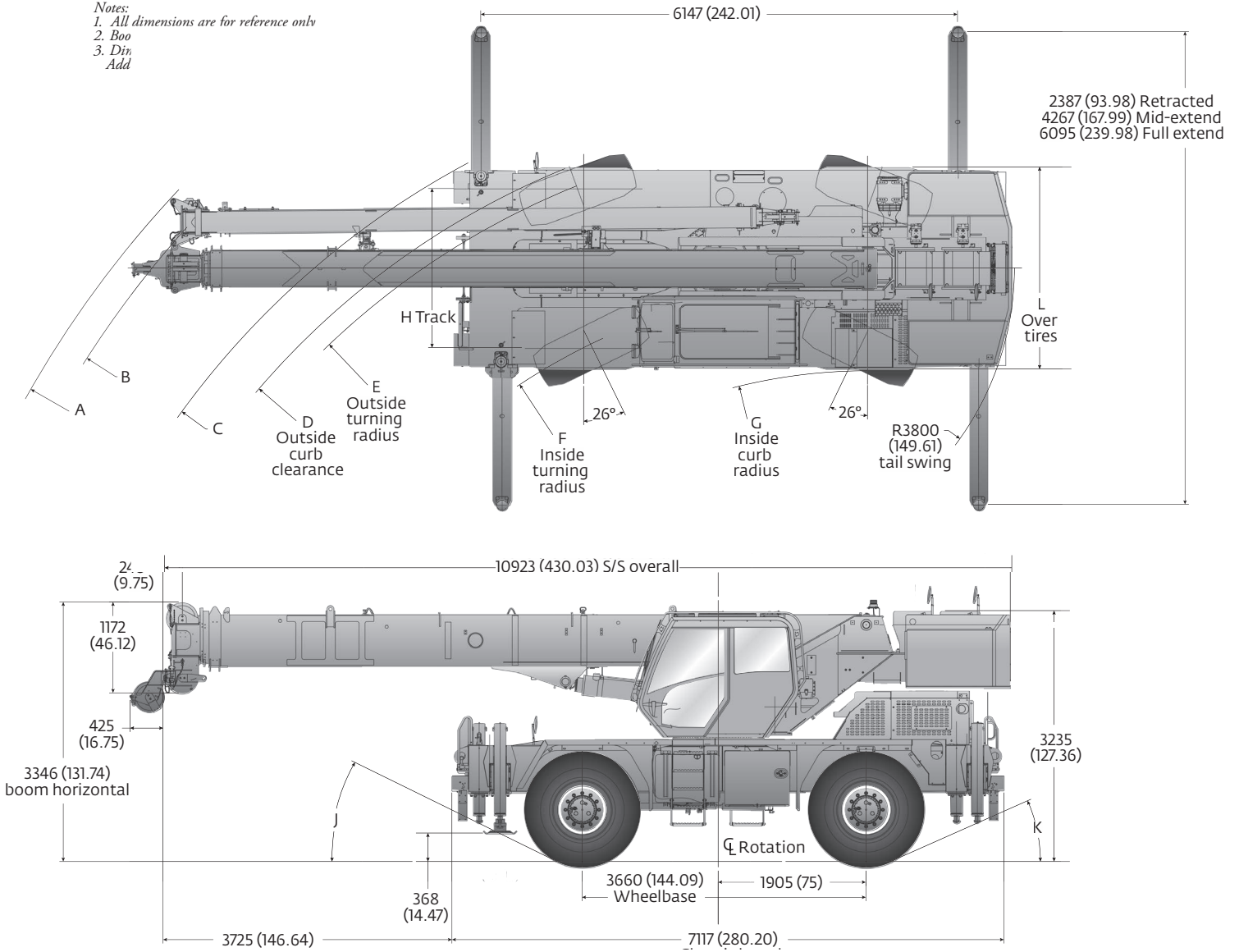

	Gross		Front		Rear	
	kg	lb	kg	lb	kg	lb
	Basic Machine: including 31 m (95 ft) main boom, main hoist with 137 m (450 ft) of rope, full counterweight + IPO, 6.8 t (7.5 USt) headache ball, and 27 t (30 USt) hook block Tier 4F engine.	26 419	58,244	11 590	25,551	14 830
Add: Auxiliary hoist + 137 m (450 ft) of 35 x 7 hoist cable and auxiliary boom nose ILO IPO counterweight	26 646	58,744	11 654	25,693	14,992	33,051
Add: 7.9 m - 13.7 m (26 ft - 45 ft) telescopic boom extension + extension hangers	27 556	60,750	13 021	28,706	14 535	32,044

Working range

102 ft main boom + 26 ft – 45 ft extension

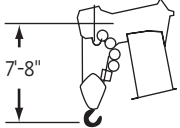
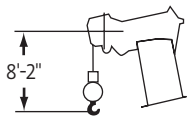
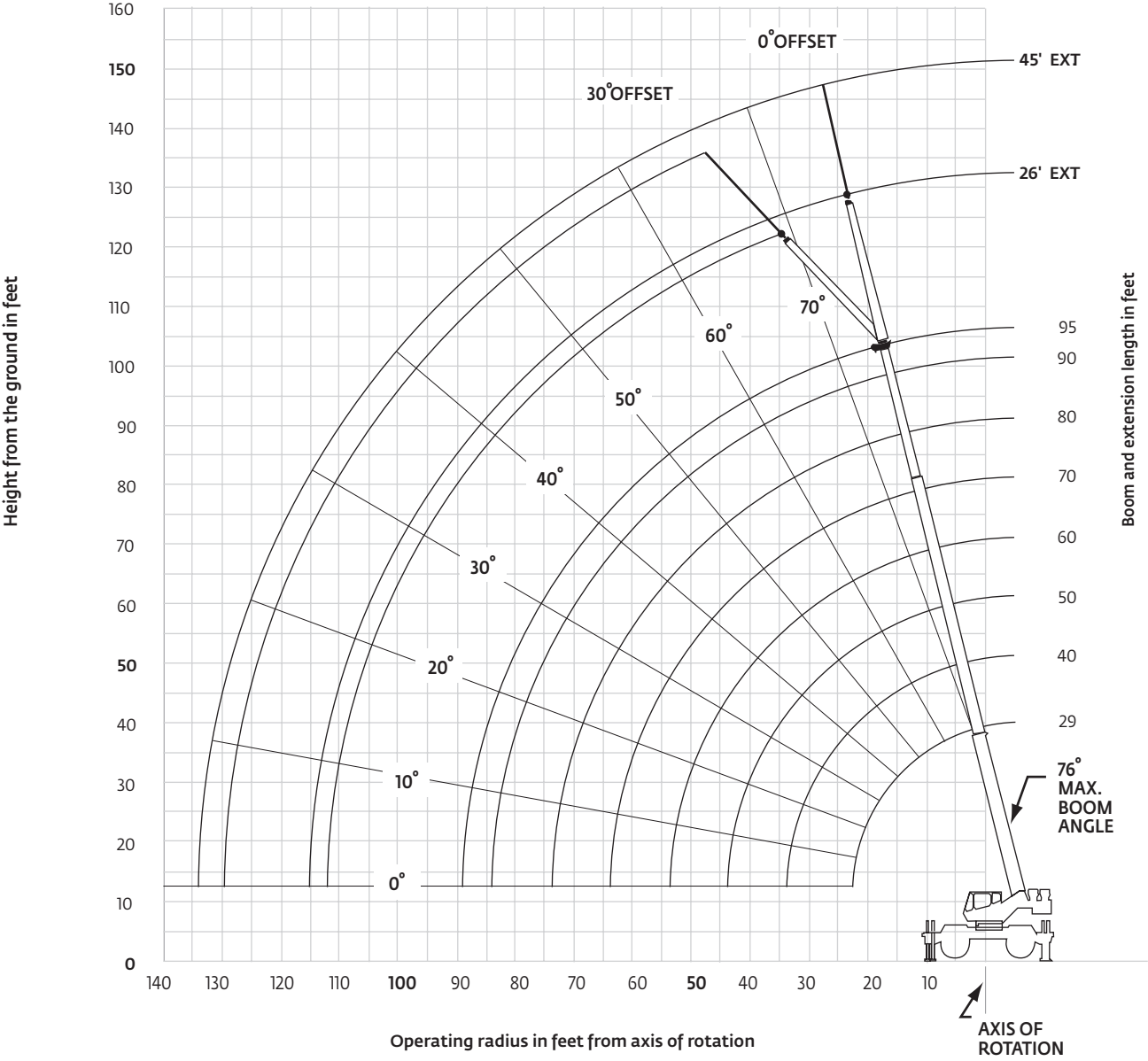

Dimensions are for largest Grove furnished hookblock and headache ball, with anti-two block activated.

Load chart



Feet	Main boom length in feet							
	29	40	50	60	70	80	90	95
10	60,000 (60.5)	50,100 (69.5)	46,950 (74.5)	—	—	—	—	—
12	54,650 (56)	50,100 (66.5)	44,950 (72)	38,850* (76)	—	—	—	—
15	42,850 (47.5)	43,800 (61.5)	41,050 (68)	36,000 (72)	29,450* (76)	22,450* (76)	—	—
20	30,700 (30)	31,650 (53)	32,100 (61.5)	29,500 (67)	27,400 (71)	22,450 (73.5)	18,550* (76)	15,500* (76)
25	—	24,050 (42.5)	24,500 (54.5)	24,800 (61.5)	23,100 (66.5)	19,250 (70)	16,500 (72.5)	15,300 (74)
30	—	18,800 (29)	19,250 (47)	19,550 (56)	19,600 (61.5)	16,850 (66)	14,400 (69)	13,200 (70.5)
35	—	—	15,550 (38)	15,850 (49.5)	16,000 (56.5)	14,850 (61.5)	12,700 (65.5)	11,500 (67.5)
40	—	—	12,800 (26)	12,950 (42.5)	13,000 (51.5)	13,050 (57.5)	11,000 (62)	10,000 (64)
45	—	—	—	10,450 (34.5)	10,500 (46.5)	10,550 (53)	9630 (58.5)	9060 (60.5)
50	—	—	—	8610 (23.5)	8630 (39.5)	8670 (48)	8720 (54.5)	7990 (57)
55	—	—	—	—	7170 (32)	7200 (43)	7250 (50)	7100 (53)
60	—	—	—	—	6000 (22)	6030 (37)	6100 (45.5)	6110 (49)
65	—	—	—	—	—	5080 (30)	5120 (40.5)	5150 (44.5)
70	—	—	—	—	—	4270 (20.5)	4330 (35)	4350 (40)
75	—	—	—	—	—	—	3650 (28.5)	3700 (34.5)
80	—	—	—	—	—	—	3100 (20)	3100 (28)
85	—	—	—	—	—	—	—	2600 (20)
Minimum boom angle (°) for indicated length (no load)								0
Maximum boom length (ft.) at 0° boom angle (no load)								95

*This capacity is based on maximum boom angle
NOTE: () Boom angles are in degrees.

A6-829-101755

Boom angle	Lifting capacities at 0° boom angle							
	29 ft	40 ft	50 ft	60 ft	70 ft	80 ft	90 ft	95.2 ft
0°	26,100 (22.8)	15,800 (13.8)	11,000 (43.8)	7430 (53.8)	5220 (63.8)	3730 (73.8)	2660 (83.8)	2220 (89)

NOTE: () Reference radii in feet.
Figures above the bold line indicate optimal lift capacity within boom length sections.

THIS CHART IS ONLY A GUIDE AND SHOULD NOT BE USED TO OPERATE THE CRANE.
The individual crane's load chart, operating instructions and other instructional plates must be read and understood prior to operating the crane.

Load chart

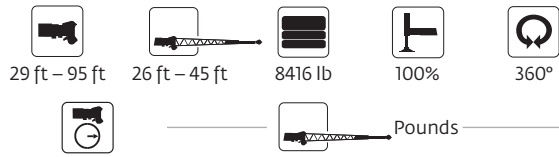

Feet	26 ft length		45 ft length	
	0° offset	30° offset	0° offset	30° offset
30	8200* (76)	—	—	—
35	8200 (73.5)	—	5250* (76)	—
40	8200 (70)	5780* (76)	5250 (75)	—
45	8120 (68.5)	5780 (73.5)	4940 (73)	—
50	7350 (66)	5360 (71)	4540 (71)	—
55	6370 (63)	4750 (68)	4150 (68.5)	2730* (76)
60	5670 (60.5)	4290 (65)	3890 (66)	2730 (74.5)
65	4820 (57.5)	3870 (62)	3740 (64)	2730 (72)
70	4200 (54.5)	3530 (59)	3600 (61.5)	2580 (69.5)
75	3680 (51.5)	3230 (56)	3470 (59)	2520 (67)
80	3080 (48.5)	3000 (52.5)	3240 (56.5)	2460 (64)
85	2520 (45)	2780 (49)	3050 (54)	2420 (61.5)
90	2050 (41)	2410 (45)	2820 (51)	2390 (58.5)
95	1670 (37)	1970 (40.5)	2480 (48.5)	2370 (55.5)
100	1370 (32.5)	1580 (35.5)	2090 (45.5)	2310 (52)
105	1020 (27.5)	—	1740 (42)	2000 (49)
110	—	—	1430 (38.5)	1580 (45)
115	—	—	1150 (35)	1260 (40.5)
120	—	—	900 (30.5)	—
Min. boom angle for indicated length (no load)	24°	30°	30°	30°
Max. boom length at 0° boom angle (no load)	80 ft		80 ft	

*This capacity is based on maximum boom angle.

A6-829-100272A

**26 ft capacities are also applicable to fixed offsettable ext.

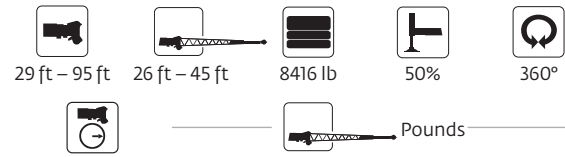

Feet	26 ft length		45 ft length	
	0° offset	30° offset	0° offset	30° offset
30	8200 (76)	—	—	—
35	8200 (73.5)	—	5250* (76)	—
40	6940 (71)	5780* (76)	5250 (75)	—
45	—	5780 (73.5)	4940 (73)	—
50	—	5360 (71)	4540 (71)	—
55	—	4750 (68)	4150 (68.5)	2730* (76)
60	—	5580 (68.5)	3490 (66)	2730 (74.5)
65	—	4490 (66)	2870 (64)	2730 (72)
70	—	3600 (63)	2340 (61.5)	2580 (69.5)
75	—	2860 (60.5)	1840 (59)	2520 (67)
80	—	2190 (57.5)	1400 (56.5)	2260 (64)
85	—	1610 (54.5)	1020 (54)	1760 (61.5)
90	—	1120 (51.5)	—	1310 (58.5)
0.1A (lb)	570	540	500	460
Min. boom angle for indicated length (no load)	44°	46°	48°	49°
Max. boom length at 0° boom angle (no load)	60 ft		60 ft	

NOTE: () Boom angles are in degrees.

A6-829-100273B

*This capacity is based on maximum boom angle.

**26 ft capacities are also applicable to fixed offsettable ext.

Boom extension capacity notes:

- All capacities above the bold line are based on structural strength of boom extension.
- 26 ft and 45 ft boom extension lengths may be used for single line lifting service.
- Radii listed are for a fully extended boom with the boom extension erected. For main boom lengths less than fully extended, the rated loads are determined by boom angle. Use only the column which corresponds to the boom extension length and offset for which the machine is configured. For boom angles not shown, use the rating of the next lower boom angle.

Warning: Operation of this machine with heavier loads than the capacities listed is strictly prohibited. Machine tipping with boom extension occurs rapidly and without advance warning.

- Boom angle is the angle above or below horizontal of the longitudinal axis of the boom base section after lifting rated load.
- Capacities listed are with outriggers fully extended and vertical jacks set only.

THIS CHART IS ONLY A GUIDE AND SHOULD NOT BE USED TO OPERATE THE CRANE.

The individual crane's load chart, operating instructions and other instructional plates must be read and understood prior to operating the crane.

Load chart

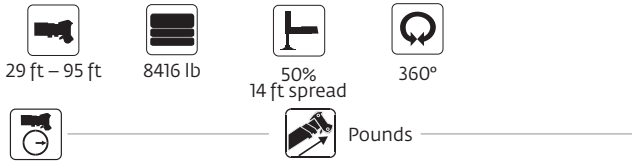

Feet	Main boom length in feet								
	29	40	50	60	70	80	90	95	
10	60,000 (60.5)	48,000 (69.5)	45,000 (74.5)	—	—	—	—	—	
12	53,300 (56)	48,000 (66.5)	44,950 (72)	37,000* (76)	—	—	—	—	
15	42,100 (47.5)	40,500 (61.5)	38,350 (68)	36,000 (72)	27,400* (76)	21,000* (76)	—	—	
20	23,950 (30)	23,850 (53)	23,900 (61.5)	24,050 (67)	23,200 (71)	21,000 (73.5)	17,000* (76)	15,500* (76)	
25	—	15,850 (42.5)	15,950 (54.5)	16,150 (61.5)	16,350 (66.5)	16,400 (70)	15,950 (72.5)	15,500 (74)	
30	—	11,350 (29)	11,500 (47)	11,650 (56)	11,800 (61.5)	12,000 (66)	12,150 (69)	12,100 (70.5)	
35	—	—	8620 (38)	8820 (49.5)	8930 (56.5)	9050 (61.5)	9190 (65.5)	9260 (67.5)	
40	—	—	6610 (26)	6820 (42.5)	6900 (51.5)	6990 (57.5)	7100 (62)	7150 (64)	
45	—	—	—	5350 (34.5)	5400 (46)	5470 (53)	5550 (58.5)	5600 (60.5)	
50	—	—	—	4220 (23.5)	4260 (39.5)	4310 (48)	4370 (54.5)	4410 (57)	
55	—	—	—	—	3350 (32)	3390 (43)	3430 (50)	3460 (53)	
60	—	—	—	—	2600 (22)	2640 (37)	2670 (45.5)	2700 (49)	
65	—	—	—	—	—	—	2050 (40.5)	2060 (44.5)	
70	—	—	—	—	—	—	1520 (35)	1530 (40)	
75	—	—	—	—	—	—	1070 (28.5)	1080 (34.5)	
0.1A (lb)	660	610	580	560	550	540	540	530	
Min. boom angle for indicated length (no load)							15°	20°	
Max. boom length at 0° boom angle (no load)							80		

NOTE: Boom angles are in degrees. A6-829-100270A
 *This capacity is based on maximum obtainable boom angle.

Boom angle	Lifting capacities at 0° boom angle on outriggers at 50% extended 360°					
	29	40	50	60	70	80
0°	18,800 (22.8)	9000 (33.8)	5400 (43.8)	3480 (53.8)	2100 (63.8)	1130 (73.8)

NOTE: () Reference radii in feet.

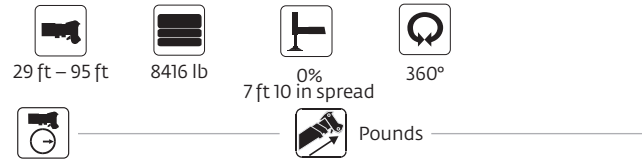

Feet	Main boom length in feet								
	29	40	50	60	70	80	90	95	
10	34,700 (60.5)	32,400 (69.5)	30,400 (74.5)	—	—	—	—	—	
12	26,200 (56)	25,400 (66.5)	24,100 (72)	22,900* (76)	—	—	—	—	
15	17,750 (47.5)	17,550 (61.5)	17,550 (68)	17,250 (72)	16,550* (76)	10,900* (76)	—	—	
20	10,650 (30)	10,600 (53)	10,650 (61.5)	10,750 (67)	11,000 (71)	10,900 (73.5)	10,500 (76)	10,350 (76)	
25	—	6930 (42.5)	7020 (54.5)	7170 (61.5)	7350 (66.5)	7560 (70)	7610 (72.5)	7490 (74)	
30	—	4670 (29)	4780 (47)	4950 (56)	5080 (61.5)	5240 (66)	5390 (69)	5480 (70.5)	
35	—	—	3270 (38)	3450 (49.5)	3550 (56.5)	3660 (61.5)	3780 (65.5)	3850 (67.5)	
40	—	—	2170 (26)	2370 (42.5)	2440 (51.5)	2520 (57.5)	2620 (62)	2670 (64)	
45	—	—	—	1550 (34.5)	1600 (46)	1660 (53)	1740 (58.5)	1780 (60.5)	
50	—	—	—	—	—	—	1050 (54.5)	1080 (57)	
0.1A (lb)	660	610	580	560	550	540	540	530	
Min. boom angle for indicated length (no load)				33°	43°	51°	53°	55°	
Max. boom length at 0° boom angle (no load)							50		

NOTE: Boom angles are in degrees. A6-829-100271A
 *This capacity is based on maximum obtainable boom angle.

Boom angle	Lifting capacities at 0° boom angle on outriggers at 50% extended 360°		
	29	40	50
0°	8310 (22.8)	3390 (33.8)	1480 (43.8)

NOTE: () Reference radii in feet.

THIS CHART IS ONLY A GUIDE AND SHOULD NOT BE USED TO OPERATE THE CRANE.

The individual crane's load chart, operating instructions and other instructional plates must be read and understood prior to operating the crane.

Load chart

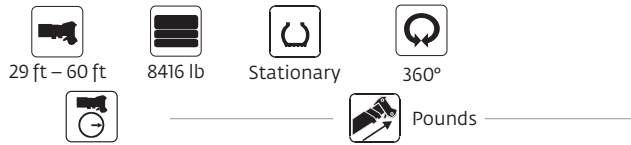

Feet	Main boom length in feet			
	29	40	50	60
10	25,550 (60.5)	25,550 (70)	16,450* (76)	—
12	20,600 (56)	20,600 (66.5)	16,450 (72)	—
15	14,350 (47.5)	14,350 (62)	14,350 (68)	14,350 (73.5)
20	8280 (30)	8280 (53)	8280 (61.5)	8280 (67)
25	—	5330 (42.5)	5330 (54.5)	5330 (61.5)
30	—	3630 (29)	3630 (47)	3630 (56)
35	—	—	2500 (38)	2500 (49.5)
40	—	—	1690 (26)	1690 (42.5)
45	—	—	—	1090 (34.5)
Min. boom angle for indicated length (no load)				34°
Max. boom length at 0° boom angle (no load)				50 ft

NOTE: () Boom angles are in degrees. A6-829-100274C
 *This capacity is based on maximum obtainable boom angle.

Boom angle	Lifting capacity at zero degree on rubber - 360°		
	29	40	50
0°	6110 (22.8)	2730 (33.8)	1210 (43.8)

NOTE: () Reference radii in feet.

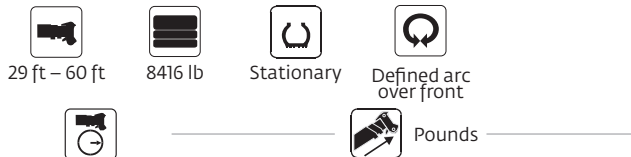

Feet	Main boom length in feet			
	29	40	50	60
10	30,100 (60.5)	26,550 (70)	16,450 (74.5)	—
12	26,550 (56)	22,100 (66.5)	16,450 (72)	—
15	22,100 (47.5)	22,100 (62)	16,450 (68)	—
20	16,050 (30)	16,050 (53)	16,050 (61.5)	—
25	—	11,005 (42.5)	11,005 (54.5)	—
30	—	8060 (29)	8060 (47)	8060 (56)
35	—	—	6110 (38)	6110 (49.5)
40	—	—	4720 (26)	4720 (42.5)
45	—	—	—	3680 (34.5)
50	—	—	—	2870 (23.5)
Min. boom angle for indicated length (no load)				0°
Max. boom length at 0° boom angle (no load)				60 ft

NOTE: () Boom angles are in degrees. A6-829-100275B

Boom angle	Lifting capacity at zero degrees on rubber - stationary - defined arc boom centered over front			
	29	40	50	60
0°	12,700 (22.8)	6500 (33.8)	3890 (43.8)	2360 (53.8)

NOTE: () Reference radii in feet.

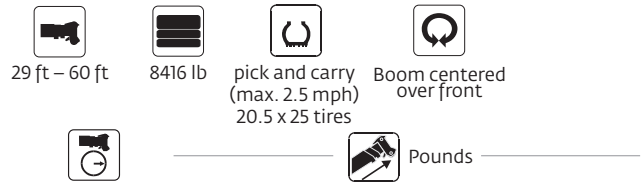

Feet	Main boom length in feet			
	29	40	50	60
10	25,900 (60.5)	25,900 (70)	18,250 (74.5)	—
12	22,350 (56)	22,350 (66.5)	18,250 (72)	—
15	18,250 (47.5)	18,250 (62)	18,250 (68)	13,350 (72.5)
20	13,350 (30)	13,350 (53)	13,350 (61.5)	13,350 (67)
25	—	10,350 (42.5)	10,350 (54.5)	10,350 (61.5)
30	—	8060 (29)	8060 (47)	8060 (56)
35	—	—	4810 (38)	4810 (49.5)
40	—	—	3770 (26)	3770 (42.5)
45	—	—	—	2930 (34.5)
50	—	—	—	2240 (23.5)
Min. boom angle for indicated length (no load)				0°
Max. boom length at 0° boom angle (no load)				60 ft

NOTE: Boom angles are in degrees. A6-829-100276B

Boom angle	Lifting capacity at zero degree on rubber Pick & Carry - boom centered over front			
	29	40	50	60
0°	11,400 (22.8)	5090 (33.8)	3110 (43.8)	1800 (53.8)

NOTE: () Reference radii in feet.

Notes to all rubber capacity charts:

- Capacities are in pounds and do not exceed 75% of tipping loads as determined by test in accordance with SAE J765.
- Capacities are applicable to machines equipped with 20.5 x 25 (24 ply) tires at 75 psi cold inflation pressure, and 16.00 x 25 (28 ply) tires at 100 psi cold inflation pressure.
- Defined Arc - Over front includes 6° on either side of longitudinal centerline of machine (ref. drawing C6-829-003529).
- Capacities appearing above the bold line are based on structural strength and tipping should not be relied upon as a capacity limitation.
- Capacities are applicable only with machine on firm level surface.
- On rubber lifting with boom extensions not permitted.
- For pick and carry operation, boom must be centered over front of machine, mechanical swing lock engaged and load restrained from swinging. When handling loads in the structural range with capacities close to maximum ratings, travel should be reduced to creep speeds.
- Axle lockouts must be functioning when lifting on rubber.
- All lifting depends on proper tire inflation, capacity and condition. Capacities must be reduced for lower tire inflation pressures. See lifting capacity chart for tire used. Damaged tires are hazardous to safe operation of crane.
- Creep - Not over 200 ft of movement in any 30 minute period and not exceeding 1 mph.

Load handling

Weight reductions for load handling devices	
26 ft offsettable boom extension	lb
Erected*	2960
26 ft – 45 ft telescopic boom extension	lb
Erected (retracted)*	4220
Erected (extended)*	5780
Reduction of main boom capacities*	
Auxiliary boom nose	lb
	142
Hook blocks and headache balls	lb
30 USt, 3-sheave	580 +
15 USt, 2-sheave	425 +
7.5 USt overhaul ball	354 +
7.5 USt headache ball	338 +

+ Refer to rating plate for actual weight

When lifting over swingaway and/or jib combinations, deduct total weight of all load handling devices reeved over main boom nose directly from swingaway or jib capacity.

NOTE: All load handling devices and boom attachments are considered part of the load and suitable allowances MUST BE MADE for their combined weights. Weights are for Grove furnished equipment.

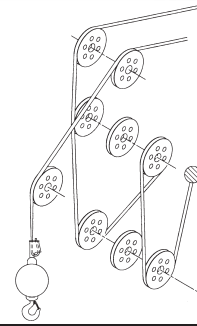

Line pulls and reeving information			
Hoists	Cable specs	Permissible line pulls	Nominal cable length
Main	16 mm (5/8 in) 6 x 37 class EIPS, IWRC Special Flexible Min. Breaking Str. 41,200 lb	11,640 lb*	450 ft
Main and auxiliary	16 mm (5/8 in) 35 x 7 Class, EEIPS+Rotation Resistant (non-rotating) Min. Breaking Str. 61,200 lb	11,640 lb*	450 ft
Main and auxiliary	18 mm (11/16 in) K™-100 Synthetic hoist rope (ISO) Min. breaking strength 63,700 lb	12,740 lb*	463 ft

The approximate weight of 5/8 in wire rope is 1.0 lb/ft. The approximate weight of 18 mm synthetic rope is 0.16 lb/ft. *With certain boom and hoist tackle combinations, the allowable line pull may be limited by hoist performance. Refer to Hoist Performance table for lift planning to ensure adequate hoist performance on drum rope layer required.

Capacity reductions for synthetic rope use:		
	Main boom charts	Extension charts
Outriggers fully extended	100 lb	0 lb
Outriggers 50% extended	480 lb	120 lb
Outriggers 0% extended	470 lb	N/A
On Rubber	210 lb	N/A

If synthetic rope is installed on either the main or aux hoist, and wire rope is installed on the other hoist, no capacity reductions are required.

Hoist performance			
Wire rope layer	Hoist line pulls two-speed hoist	Drum rope capacity (ft)	
	Low available lb*	Layer	Total
1	11,640	77	77
2	10,480	85	162
3	9,530	94	256
4	8,730	102	358
5	8,060	111	469
6	7,490	119	588

* Max lifting capacity: 6 x 37 class = 11,640 lb
35 x 7 class = 11,640 lb

Working area diagram

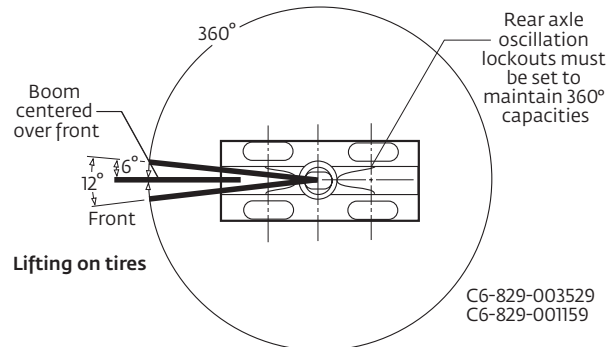
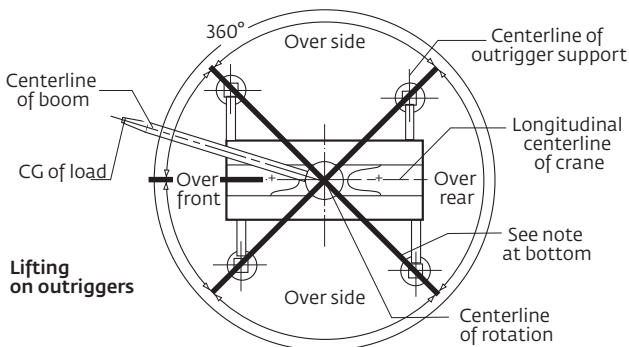

C6-829-003529
C6-829-001159

Bold lines determine the limiting position of any load for operation within working areas indicated.

For specific configurations refer to www.cranelibrary.com.

THIS CHART IS ONLY A GUIDE AND SHOULD NOT BE USED TO OPERATE THE CRANE.

The individual crane's load chart, operating instructions and other instructional plates must be read and understood prior to operating the crane.

Superstructure



Boom

8,8 m – 29,0 m (29 ft – 95 ft) four-section, synchronized full-power boom. Maximum tip height: 31,2 m (102.5 ft).



Optional telescopic swingaway extension*
7,9 m – 13,7 m (26 ft – 45 ft) offsettable telescopic lattice swingaway extension. Offsets at 0° and 30°. Stows alongside base boom section.

Maximum tip height: 44,5 m (146 ft).



Boom nose

Three nylatron sheaves mounted on heavy duty tapered roller bearings with removable pin-type rope guards. Quick reeve type boom nose.



Boom elevation

One double-acting hydraulic cylinder with integral holding valve provides elevation from -3° to +76°.



Crane Control System (CCS)

“Graphic Display” load moment and anti-two block system with audio-visual warning and control lever lockout. This system provides electronic display of boom angle, length, radius, tip height, relative load moment, maximum permissible load, load indication and warning of impending two-block condition. The Work Area Definition System allows the operator to pre-select and define safe working areas. If the crane approaches the pre-set limits, audio-visual warnings aid the operator in avoiding jobsite obstructions.



Cab

Full-vision, all-steel fabricated with acoustical lining and tinted safety glass throughout. Adjustable deluxe seat incorporates armrest-mounted electronic single or dual axis controllers and a jog dial for easier data input. Tilt/telescoping steering wheel with various controls incorporated into the steering column. Other standard features include hot water heater, cab circulating air fan, sliding side and rear windows, sliding skylight with electric wiper and sunscreen, electric windshield wash/wipe, fire extinguisher, seat belt, air conditioning and dual cab mounted work light.



Swing

Single speed, planetary swing drive with foot applied multi-disc wet brake. Spring applied, hydraulically released swing brake. Single position mechanical house lock, operated from cab. Maximum speed: 2 rpm.



Counterweight

3817 kg (8416 lb) pinned to superstructure.



Hydraulic system

Two main pumps ([1] piston and [1] gear) with a combined capacity of 316,5 L/min (83.6 gpm).

Maximum operating pressure: 275,7 bar (4000 psi).

Three section pressure compensated valve bank. Return line type filter with full flow by-pass protection and service indicator. Replaceable cartridge with micron filtration rating of 5/12/16. 396 L (104.6 gal) hydraulic reservoir. System pressure test ports.



Hoist specifications (HPI5C-17G) main and auxiliary hoist

Planetary reduction with automatic spring applied multi-disk wet brake. Electronic hoist drum rotation indicators, and hoist drum cable followers.

Hoist maximum single line pull:

1st layer: 5280 kg (11,640 lb)

3rd layer: 4323 kg (9530 lb)

5th layer: 3656 kg (8060 lb)

Maximum permissible line pull:

5280 kg (11,640 lb) with 35 x 7 class rope

Maximum single line speed: 136 m/min (445 fpm)

Rope construction:

35 x 7 Rotation Resistant

Rope diameter: 16 mm (5/8 in)

Rope length:

Main hoist: 137 m (450 ft)

Auxiliary hoist: 137 m (450 ft)

Maximum rope stowage: 181 m (596 ft)

Carrier



Chassis

Box section frame fabricated from high-strength, low alloy steel. Front/rear towing, lifting, and tie down lugs.



Outrigger system

Four hydraulic telescoping single-stage double box beam outriggers with inverted jacks and integral holding valves.

Three position setting, 0%, 50% and fully extended. All steel fabricated quick release type outrigger floats, 362 mm (14.25 in) square.

Maximum outrigger pad load: 24 857 kg (54,800 lb)

Outrigger monitoring system with outrigger beam position display on R.C.L. screen (required in North America, Canada, and European Union countries).



Outrigger controls

Controls and crane level indicator located in cab. Extension and retraction are through the CCS system.

Specifications

Carrier *(cont'd)*



Engine (Tier 4F)

Cummins QSB 6.7L diesel six cylinder, turbo-charged with Cummins Compact Catalyst (CCC) & selective catalytic reduction (SCR) combo muffler, using diesel exhaust fluid (DEF) injection. Meets emission per U.S. Tier 4F and E.U. Stage IV. 122 kW (164 bhp) at 2300 rpm. Maximum torque: 732 Nm (540 ft lb) at 1500 rpm. Fuel requirement: Maximum of 15 ppm sulfur content (ultra-low sulfur diesel fuel) and diesel exhaust fluid (DEF). Note: Tier 4F engine required in North American, Canada and European Union countries.



Engine (Tier 3)

Cummins QSB 6.7 L diesel, six cylinders, 119 kW (160 bhp) (gross) at 2500 rpm.
Maximum torque: 731 Nm (539 ft-lb) at 1500 rpm.



Fuel tank capacity

220 L (58 gal)



Transmission

Range-shift six-speed (three speeds x two range, both forward and reverse)



Electrical system

Two (2) 12 V maintenance free batteries. 24 V starting and lighting. Battery disconnect. Full CANBUS diagnostic system.



Drive

4 x 4



Steering

Fully independent power steering.

Front: Full hydraulic steering wheel controlled.

Rear: Full hydraulic switch controlled.

Provides infinite variations with four main steering modes: front only, rear only, crab and coordinated.

Rear steer indicator.

Outside turning radius: 5,8 m (19.1 ft)

Inside turning radius: 4 m (13.1 ft)



Axles

Front: Drive/steer with differential and planetary reduction hubs rigid mounted to frame.

Rear: Drive/steer with differential and planetary reduction hubs pivot mounted to frame.



Oscillation lockouts

Automatic full hydraulic lockouts on rear axle permits 18,8 cm (7 in) oscillation with boom centered over the front only.



Brakes

Full hydraulic split circuit disc-type brakes operating on all wheels. Spring-applied, hydraulically released parking brake mounted on front axle.



Tires

Standard: 20.5 x 25 - 24 bias ply

*Option: 16.0 x 25 - 28 bias ply



Lights

Full lighting including turn indicators, head, tail, brake and hazard warning lights.



Maximum speed

40 km/h (25 mph) at 2500 rpm



Gradeability (theoretical)

119% (at engine stall)(Based on 27 556 kg [60,750 lb] GVW) 20.5 x 25 tires, 29 m (95 ft) main boom, plus 13,7 m (45 ft) telescopic swingaway, 3817 kg (8416 lb) counterweight, 27 t (30 USt) hook block and 6,8 t (7.5 USt) headache ball.



































Miscellaneous standard equipment

Full width steel fenders, full length steel decking with anti-skid, dual rear view mirrors, hook block tied-down, electronic back-up alarm, light package, front stowage well, tachometer/hourmeter, rear wheel position indicator, hot water cab heater, air conditioning, hoist mirrors, engine distress A/V warning system, front/rear tie-down and tow lugs, coolant sight level indicator, CraneSTAR asset management system.

*Optional equipment

- Value package: Includes 7,92 m – 13,7 m (26 ft – 45 ft) telescoping swingaway and 360° positive swing lock
- Auxiliary Hoist Package: Includes model HP15C-17G auxiliary hoist with electronic hoist drum rotation indicator, hoist drum cable follower, 137 m (450 ft) of 16 mm (5/8 in) 35 x 7 class wire rope and auxiliary sheave boom nose.
- 360° positive mechanical swing lock
- Rear pintle hook
- Cab-controlled cross axle differential locks (front and rear)
- PAT event recorder download kit
- Single axis electric controllers
- Third wrap indicator with hoist cut-out for main hoist or main and auxiliary hoist
- Vertical LMI light Tower (externally mounted)
- Synthetic rope for main and/or auxiliary hoist
- Emergency stop buttons on each side of carrier
- Second beacon light
- -29°C / -20°F cold weather package
- -40°C / -40°F arctic weather package

Symbol glossary

 Axles	 Crane control system	 Heavy duty jib	 Outriggers
 Boom	 Drive	 Height (no max)	 Radius
 Boom elevation	 Electrical system	 Hoist	 Rotation
 Boom extension	 Engine	 Hook block	 Speed
 Boom length	 Extension	 Hydraulic system	 Steering
 Boom nose	 Frame	 Insert	 Suspension
 Brakes	 Fuel tank capacity	 Lights	 Swing
 Cab	 Gear	 Oil	 Tires
 Counterweight	 Grade	 Outrigger controls	 Transmission

Notes

Manitowoc Cranes

Regional headquarters

Americas

Manitowoc, Wisconsin, USA

Tel: +1 920 684 6621

Fax: +1 920 683 6277

Shady Grove, Pennsylvania, USA

Tel: +1 717 597 8121

Fax: +1 717 597 4062

Europe, Middle East, Africa

Dardilly, France - TOWERS

Tel: +33 (0)4 72 18 20 20

Fax: +33 (0)4 72 18 20 00

Wilhelmshaven, Germany - MOBILE

Tel: +49 (0) 4421 294 454

Fax: +49 (0) 4421 2944301

China

Shanghai, China

Tel: +86 21 6457 0066

Fax: +86 21 6457 4955

Greater Asia-Pacific

Singapore

Tel: +65 6264 1188

Fax: +65 6862 4040



Manitowoc Crane Care when you need it.

The assurance of the world's most advanced crane service and support to get you back to work fast.



Manitowoc Finance helps you get right to work generating profits for your business.

Financial tools that help you capitalize on opportunity with solutions that fit your needs.

This document is non-contractual. Constant improvement and engineering progress make it necessary that we reserve the right to make specification, equipment, and price changes without notice. Illustrations shown may include optional equipment and accessories and may not include all standard equipment.