



Absolutely The Best Crane Mats In The World.

This document is stored and available in the Raptor Tech Technical Document Repository.

To help our customers understand certain critical data points that factor into purchasing crane mats, Raptor Tech maintains a repository of technical documents with data from all major crane manufacturers.

You can visit Raptor Tech's repository to get crane specifications and technical details for crane models in addition to this model at:

<https://library.steelcranemats.com>

Thank You for Visiting the [SteelCraneMats.com](https://library.steelcranemats.com) Technical Specifications Document Repository.



QUADSTAR 1075

75t capacity class

Rough terrain crane

Datasheet

metric

QUADSTAR 1075



WORKS FOR YOU.™

	Page · Page · Seite · Pagina · Página · Página · Страница:
Key · Légende · Legende · Legenda · Lejenda · Legenda · Условные Обозначения	3
Highlights · Atouts majeurs · Produktmerkmale · Caratteristiche principali · Características destacadas · Destaques	4
Основные функции	
Dimensions · Dimensions · Abmessungen · Dimensioni · Dimensiones · Dimensões · Размеры	5
Weights · Poids · Gewichte · Pesi · Pesos · Pesos · Вес	6
Steering Radii · Rayon de braquage · Lenkradien · Raggi di sterzata · Radios de dirección · Raios de giro · Радиусы поворотов...	7
Range Graph · Diagramme de charge · Arbeitsbereich · Campo di portata · Diagrama de carga · Gráfico de alcance	8, 10
Диаграмма рабочей зоны	
Load Chart · Graphique de charge · Traglasttabelle · Diagramma di carico · Tabla de carga · Tabela de carga · Таблица нагрузок...	9, 11
Technical Specifications · Spécifications techniques · Technische Daten · Specifica tecnica · Especificación técnica · Especificações técnicas · Технические характеристики	
Boom · Flèche · Ausleger · Braccio · Pluma · Lança · Стрела	12
Hoist · Treuil · Hubwerk · Argano · Cabrestante · Guincho · Подъем	12
Upper Structure · Tourelle · Oberwagen · Superestructura · Sovrastruttura · Estrutura superior · Верхняя надстройка	13
Cab and Controls	13
Cabine et commandes · Kabine und Steuerung · Cabina e comandi · Cabina y controles · Cabine e controles · Кабина и органы управления	
Carrier · Châssis · Unterwagen · Carro · Chasis · Chassi · Шасси	14
Vehicle Performance	15
Performances du véhicule · Fahrleistungen · Prestazioni veicolo · Prestaciones del vehículo · Desempenho do veículo · Характеристики автомобиля	
Tires · Pneumatiques · Bereifung · Pneumatici · Neumáticos · Pneus · Шины	15
Options · Options · Optionen · Opzionali · Opciones · Opcionais · Дополнительные опции	15-17
Notes to lifting capacity · Notes relatives à la capacité de levage · Hinweis zu Tragfähigkeiten	19
Annotazioni sulle portate · Notas sobre la capacidad de elevación · Notas sobre a capacidade de içamento · Примечания по грузоподъемности	

LÉGENDE · LEGENDE · LEGENDA · LEJENDA · LEGENDA · УСЛОВНЫЕ ОБОЗНАЧЕНИЯ

	Counterweight · Contrepoids · Gegengewicht · Contrappeso · Contrapeso · Contrapeso · Противовес		Boom extension · Extension de flèche · Ausleger-Verlängerung · Prolunga · Extensión · Extensão da lança · Удлинитель стрелы
	Main boom · Flèche principale · Hauptausleger · Braccio principale · Pluma principal · Lança principal · Главная стрела		Performance · Performance · Leistungswerte · Prestazioni · Prestaciones · Desempenho · Характеристики
	Boom length · Longueur de flèche · Auslegerlänge · Lunghezza del braccio · Longitud pluma · Comprimento da lança · Длина стрелы		Boom elevation angle · Angle de relevage de la flèche · Auslegerwinkel · Angolo di brandeggio · Angulo elevación pluma · Angulo elevação lança · Угол стрелы
	Tip height · Hauteur de déversement · Rollenhöhe · Altezza di testa · Altura de la punta · Altura da ponta · Высота вершины		Working radius · Portée · Ausladung · Raggio di lavoro · Radio de trabajo · Raio de operação · Рабочий радиус
	Angular offsets · Déports angulaires · Abwinkelbar · Inclinações · Inclinação · Desvío angular · Угловое смещение		Minimum distance between hook block and boom head · Distance entre crochet et tête de flèche · Haken bis Rollenachse · Distancia mínima tra bozzello e testa braccio · Distancia mínima gancho a cabeça pluma · Distância mínima entre moitão e cabeça da lança · Минимальное расстояние от крюка до оси шкива вершины
	Aux head · Tête auxiliaire · Zusatzkopf · Testa auxiliaria · Cabeza auxiliar · Cabeça auxiliar · Дополнительная головка		Slewing locked · Orientation bloquée · Schwenksperre · Rotazione bloccata · Giro bloqueado · Giro bloqueado · Поворот блокирован
	Slewing / Allowable range · Orientation / Rayon admissible · Schwenken / zulässiger Bereich / Hub mit Abstützung · Stabilizzatori / Sollevamento su stabilizzatori · Estabilizadores / Elevación sobre estabilizadores · Patolas / Elevação sobre patolas · Опоры/подъем на опорах		Slewing gears · Réducteurs d'orientation · Schwenkwerk · Sistema di rotazione · Sistema de giro · Engrenagens do giro · Редукторы поворота
	Outriggers / Lifting on outriggers · Stabilisateurs / Levage sur stabilisateurs · Abstützungen / Hub mit Abstützung · Stabilizzatori / Sollevamento su stabilizzatori · Estabilizadores / Elevación sobre estabilizadores · Patolas / Elevação sobre patolas · Опоры/подъем на опорах		Lifting on wheels / Pick & Carry · Levage sur roues / Pick & Carry · Nicht abgestützter Hub / Pick & Carry · Sollevamento su ruote / Pick & Carry · Elevación sobre ruedas / pick & carry · Elevação sobre rodas / Guindaste industrial · Подъем на колесах/Подъем и перенос
	Main hoist · Treuil principal · Haupthubwerk · Argano principale · Cabrestante principal · Guincho principal · Главный подъем		Auxiliary hoist · Treuil auxiliaire · Zusatzhubwerk · Argano auxiliar · Cabrestante auxiliar · Guincho auxiliar · Вспомогательный подъем
	Hoist speed · Vitesse du treuil · Geschwindigkeit des Hubwerks · Velocità argano · Velocidad cabrestante · Velocidade guincho · Скорость подъема		Rope length · Longueur de câble · Seillänge · Lunghezza fune · Longitud cable · Compr. cabo · Длина троса
	Rope · Câble · Seil · Fune · Cable · Cabo · Трос		Line pull · Traction du câble · Seilzug · Tiro sulla fune · Tracción cable · Tração linha · Нарпузка на трос
	Rope diameter · Diamètre du câble · Seildurchmesser · Diametro della fune · Diámetro cable · Diámetro do cabo · Диаметр троса		Tires · Pneumatiques · Bereifung · Pneumatici · Neumáticos · Pneus · Шины
	Hook block · Crochet-moufle · Unterflasche · Bozzello · Gancho · Moitão · Крюкоблок		Engine · Moteur · Motor · Motore · Motor · Motor · Двигатель
	Cab · Cabine · Kabine · Cabina · Cabina · Cabine · Кабина		Steering · Direction · Lenkung · Sterzata · Dirección · Direção · Рулевое управление
	Controls · Commande · Bedienelemente · Comandi · Controles · Controles · Опр. управления		Speed · Vitesse · Fahrgeschwindigkeit · Velocità di traslazione · Velocidad · Velocidade · Скорость
	Mechanical transmission · Méc. transmission · Schaltgetriebe · Trasmisione meccanica · Transmisión mecánica · Transmissão mecânica · Механическая трансмиссия		Heating / Air conditioning · Chauffage / Climatisation · Heizung / Klimaanlage · Riscaldamento / Aria condizionata · Calefacción / Climatización · Calefação / Ar condicionado · Обогрев/кондиционер
	HYDR · Hydraulics · Hydraulique · Hydraulik · Sistema idraulico · Sistema hidráulico · Sistema hidráulico · Гидравлическая система		Gradeability · Tenue de route en côte · Steigfähigkeit · Inclinação máxima superabile · Pendiente máx. · Capacidade de rampa · Способность преодолевать подъем
	Operation temperature · Température de service · Betriebstemperatur · Temperatura di lavoro · Temperatura de servicio · Temperatura operação · Рабочая температура		Gross vehicle weight · Poids en charge du véhicule · Fahrzeug-Gesamtgewicht · Peso lordo del veicolo · Peso bruto vehiculo · Peso sobre o eixo dianteiro · Полный вес крана
	Lights · Les feux · Beleuchtung · Luci · Luces · Fáróis · Освещение		Weight on front axle · Poids sur l'essieu avant · Achslast Vorderachse · Peso sull'assale anteriore · Peso eje delantero · Peso sobre o eixo dianteiro · Нарпузка на переднюю ось
	Crane / Crane in standard configuration · Grue / Grue en configuration standard · Kran / Kran in Standardkonfiguration · Gru / Gru in configurazione standard · Grúa / Grúa configuración estándar · Guindaste / Guindaste na configuração padrão · Кран/кран в стандартной комплектации		Weight on rear axle · Poids sur l'essieu arrière · Achslast Hinterachse · Peso sull'assale posteriore · Peso eje trasero · Peso sobre o eixo traseiro · Нарпузка на заднюю ось
	Crane without counterweight · Grue sans contrepoids · Kran ohne Gegengewicht · Gru senza contrappeso · Grúa sin contrapeso · Guindaste sem contrapeso · Кран без противовесов		No. of sheaves · Nombre de poulies · Anzahl Rollen · Numero di pulegge · N° poleas · N° roldanas · Кол-во шкивов
	Rated weight on hook block · Poids nominal sur crochet moufle · Nenngewicht an Unterflasche · Carco nominale al bozzello · Carga nominal en gancho · Peso nominal no moitão · Ном. нагрузка на крюкоблок		Rams-horn hook · Double crochet · Doppelhaken · Gancho ad ancora · Aparejo gancho doble · Gancho ch. carneiro · Двойной крюк
	No. of lines · Nombre de lignes · Anzahl Seile · Numero di taglie · N° ramales · N° cabos · Кол-во тросов		Differential lock · Blocage du différentiel · Differenzialsperre · Blocco differenziale · Bloqueo diferencial · Bloqueio do diferencial · Блокировка дифференциала
	Single hook · Crochet simple · Haken einzeln · Gancho singolo · Gancho simple · Gancho simples · Однорогой крюк		
	Electric circuit · Circuit électrique · Elektrische Anlage · Circuito elettrico · Circuito eléctrico · Extensão da lança · Гидропневматический тормоз		

HIGHLIGHTS

QUADSTAR 1075

ATOUS MAJEURS · PRODUKTMERKMALE · CARATTERISTICHE PRINCIPALI ·
CARACTERÍSTICAS DESTACADAS · DESTAQUES · ОСНОВНЫЕ ФУНКЦИИ

- ▶ Rated capacity · Capacité nominale · Nenntraglast · Capacità nominale · Capacidad nominal · Capacidade nominal ·
Номинальная грузоподъемность:
75 t at 3 m working radius
75 t à 3 m de portée
75 t bei 3 m Ausladung
75 t a 3 m dall'asse di rotazione
75 t a 3 m radio de trabajo
75 t a 3 m raio de operação
75 т рабочий радиус на 3 м
- ▶ Maximum main boom length · Longueur max. de flèche · Max. Auslegerlänge · Lunghezza massima braccio telescopico ·
Longitud de pluma máx. · Comprimento máximo da lança · Максимальная длина стрелы:
34 m
- ▶ Maximum tip height · Hauteur max. de déversement · Max. Rollenhöhe · Altezza di testa massima · Altura de la punta máx. ·
Altura da ponta máx. · Максимальная высота вершины:
37 m
- ▶ Maximum hook height · Hauteur max. au crochet · Max. Hakenhöhe · Altezza massima del gancio · Altura de gancho máxima ·
Altura máxima do gancho · Максимальная высота до крюка:
35 m



DIMENSIONS

QUADSTAR 1075



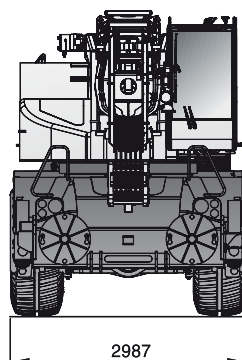
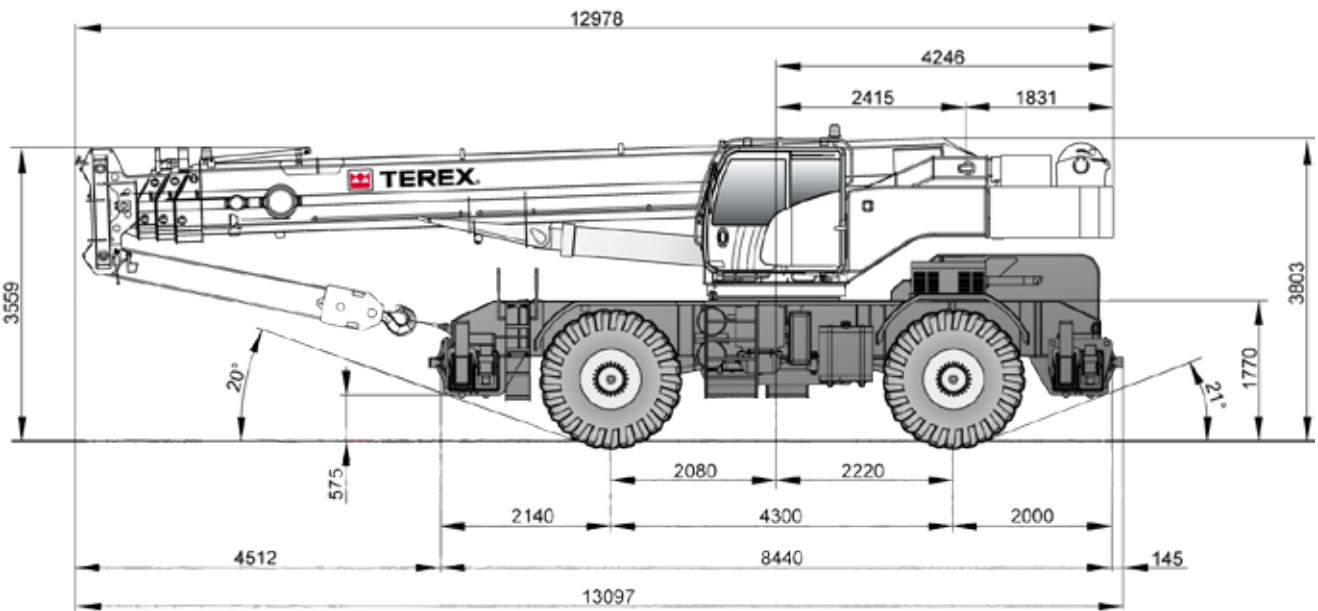
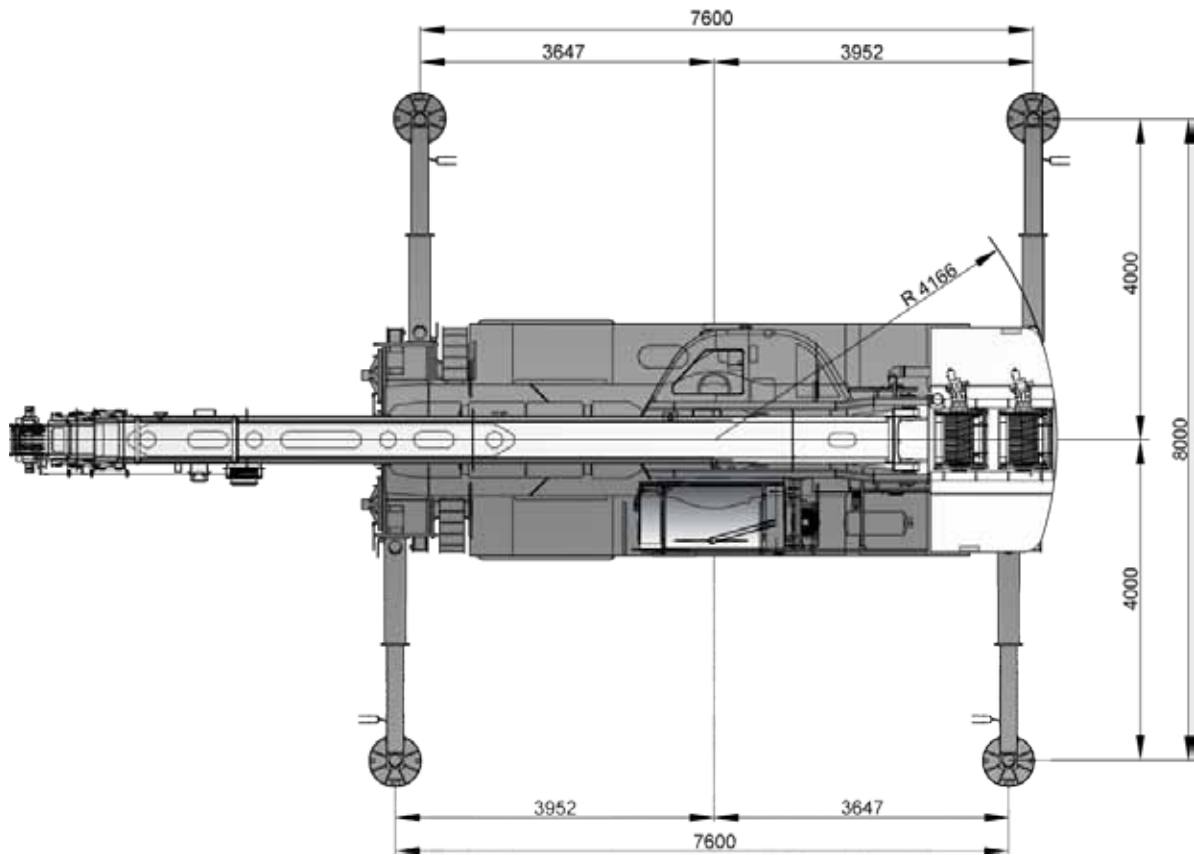





DIMENSIONS · ABMESSUNGEN · DIMENSIONI · DIMENSIONES · DIMENSÕES · РАЗМЕРЫ

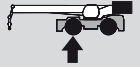
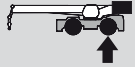
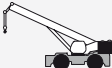

WEIGHTS

QUADSTAR 1075

POIDS · GEWICHTE · PESI · PESOS · PESOS · BEC

				
	without hook block · sans crochet moufle · ohne Unterflasche · senza bozello · sin gancho · sem moitão · п/ Крюкоблок	44 750 kg	20 750 kg	24 000 kg
Add / Subtract for main optional equipment · Supplément / retrait de poids pour équipement optionnel · Für optionale Ausstattung hinzufügen / abziehen · Da sommare a seconda dell'allestimento opzionale · Sumar / restar para equipamiento opcional principal · Acrescentar / subtrair para principais equipamentos opcionais · Добавить/вычесть для дополнительного оборудования				
	8 m stowed aside the boom · escamotable sur le côté de la flèche · seitlich am Ausleger verstaut · staffata a lato braccio · almacenado lateralmente a la pluma · guardada na lateral da lança · складываемая сбоку на главной стреле	+ 600 kg	+ 1050 kg	- 450 kg
	2 **	+ 830 kg	- 155 kg	+ 985 kg
	75 t*	+ 750 kg	+ 1860 kg	- 1100 kg
	40 t*	+ 485 kg	+ 1200 kg	- 718 kg
	40 t*	+ 485 kg	+ 1200 kg	- 718 kg
	12.5 t*	+ 255 kg	+ 633 kg	- 377 kg
	8 t*	+ 160 kg	+ 397 kg	- 237 kg

NOTE: Values are subject to 2% variation · REMARQUE : Les valeurs sont sujettes à une variation de 2% · HINWEIS: Werte können bis zu 2% abweichen ·
NOTA: I valori possono variare fino al 2% · NOTA: Valores sujetos a una variación del 2% · OBSERVAÇÃO: Valores sujeitos a 2% de variação ·
ПРИМЕЧАНИЕ. Значения даны с допуском +/- 2%

* Weight distribution calculated considering the hook block linked to the front shield of the machine · Répartition du poids calculée en considérant le crochet moufle connecté au panneau frontal de la machine · Berechnung der Gewichtsverteilung mit Hakenflasche am vorderen Rammschutz des Krans gesichert · Le distribuzioni dei pesi sono calcolate considerando il bozello legato davanti al carro · Distribución de pesos calculada considerando el gancho asegurado al protector frontal · Distribuição de pesos calculada considerando o moitão ligado à proteção dianteira da máquina · Распределение нагрузки рассчитано для крана с крюкоблоком, закрепленном на переднем щите машины

** Weight includes rope · Le poids comprend le câble · Gewicht einschließlich Seile · I pesi includono la fune · El peso incluye soporte cabrestante · Peso inclui cabo · Вес включает вес троса

STEERING RADII

QUADSTAR 1075

RAYON DE BRAQUAGE · LENKRADIEN · RAGGI DI STERZATA ·
RADIOS DE DIRECCIÓN · RAIOS DE GIRO · РАДИУСЫ ПОВОРОТОВ

**Two wheel steer · Deux roues directrices · Zweiradlenkung · Sterzata a due ruote ·
Dirección en dos ruedas · Direção em duas rodas · Поворот на двух колесах**

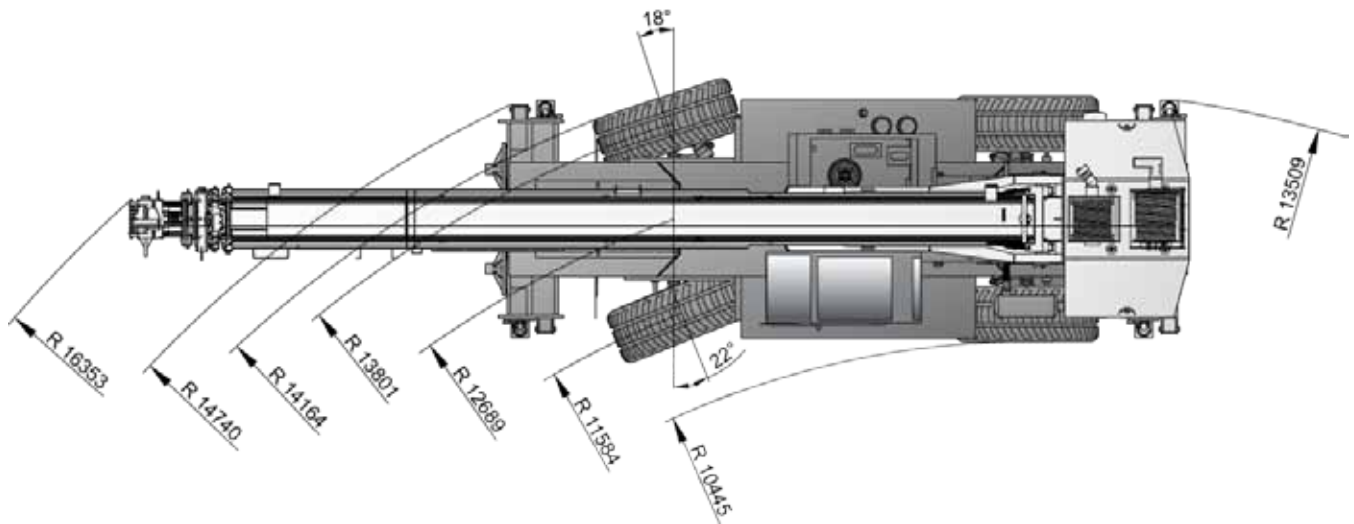

**Four wheel steer · Quatre roues directrices · Allradlenkung · Sterzata a quattro ruote ·
Dirección en cuatro ruedas · Direção em quatro rodas · Поворот на четырех колесах**

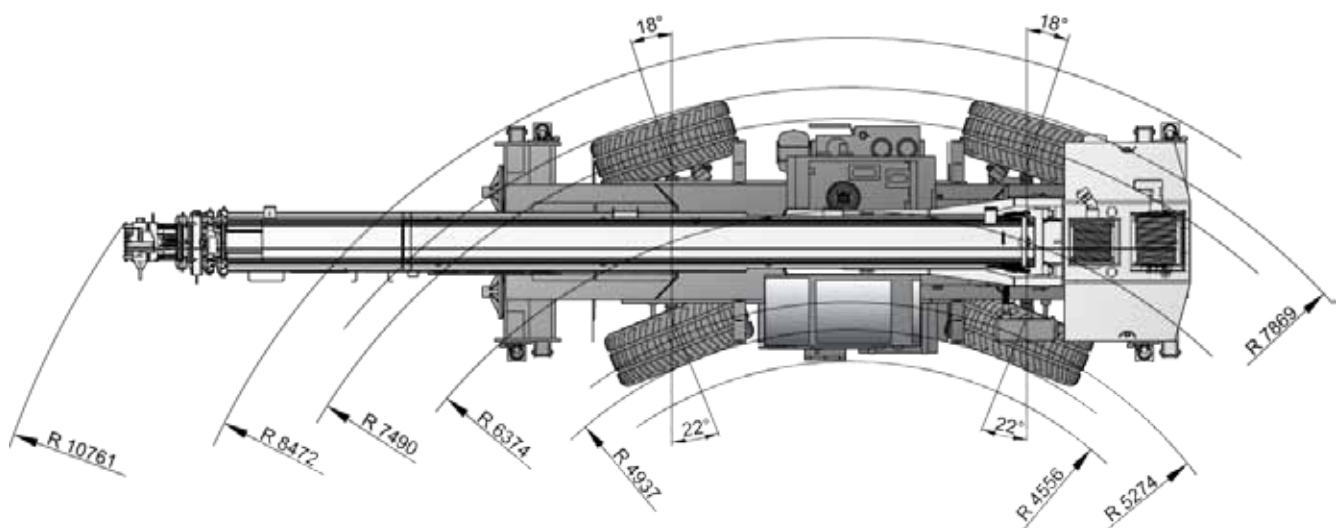

RANGE GRAPH

QUADSTAR 1075



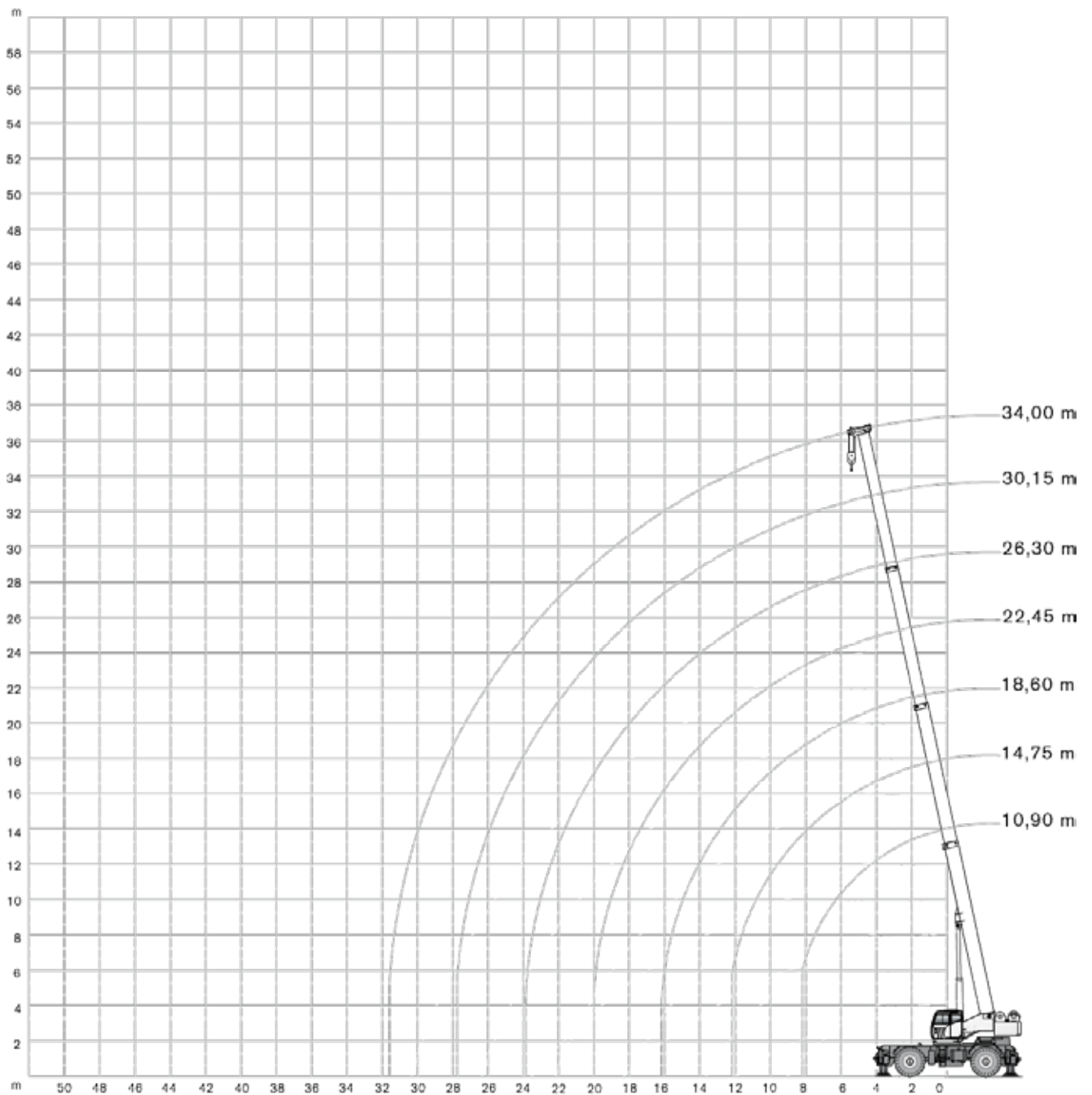
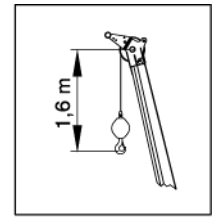
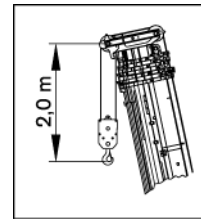





DIAGRAMME DE CHARGE · ARBEITSBEREICH · CAMPO DI PORTATA ·
 DIAGRAMA DE CARGA · GRÁFICO DE ALCANCE · ДИАГРАММА РАБОЧЕЙ ЗОНЫ



LOAD CHART

QUADSTAR 1075

GRAPHIQUE DE CHARGE · TRAGLASTTABELLE · DIAGRAMMA DI CARICO ·
TABLA DE CARGA · TABELA DE CARGA · ТАБЛИЦА НАГРУЗОК

		8 t		7,60 x 8,0 m		360°		EUROPEAN STANDARD EN 13000	
									
	10,90 m	14,80 m	18,60 m	22,50 m	26,30 m	30,20 m	34,00 m		
m	t	t	t	t	t	t	t	t	m
3,0	75,00	55,15	37,70	31,80	-	-	-	-	3,0
3,5	67,60	54,00	37,65	32,45	-	-	-	-	3,5
4,0	63,60	53,05	37,65	33,15	28,55	-	-	-	4,0
4,5	60,10	52,10	37,70	31,50	27,00	-	-	-	4,5
5,0	54,90	51,30	36,00	29,70	25,70	20,70	-	-	5,0
6,0	44,30	44,00	31,90	26,50	23,30	18,70	16,00	-	6,0
7,0	37,10	37,00	28,55	23,90	21,00	17,10	14,50	-	7,0
8,0	29,85	28,90	25,70	21,70	19,00	15,60	13,30	-	8,0
9,0	-	23,40	23,40	19,90	17,40	14,40	12,00	-	9,0
10,0	-	18,70	17,85	18,30	16,00	13,30	11,10	-	10,0
11,0	-	15,70	14,80	15,55	14,80	12,40	10,30	-	11,0
12,0	-	13,40	12,45	13,15	13,70	11,60	9,60	-	12,0
13,0	-	-	10,65	11,35	11,80	10,90	9,20	-	13,0
14,0	-	-	9,90	9,82	10,30	10,30	8,50	-	14,0
15,0	-	-	9,40	8,60	9,10	9,70	8,00	-	15,0
16,0	-	-	8,40	7,60	8,00	8,30	7,70	-	16,0
17,0	-	-	-	6,65	7,10	7,45	7,00	-	17,0
18,0	-	-	-	5,90	6,35	6,65	6,60	-	18,0
19,0	-	-	-	5,60	5,70	6,00	6,30	-	19,0
20,0	-	-	-	5,30	5,10	5,35	5,60	-	20,0
21,0	-	-	-	-	4,55	4,85	5,10	-	21,0
22,0	-	-	-	-	4,10	4,40	4,60	-	22,0
23,0	-	-	-	-	3,90	3,95	4,20	-	23,0
24,0	-	-	-	-	-	3,60	3,85	-	24,0
25,0	-	-	-	-	-	3,25	3,50	-	25,0
26,0	-	-	-	-	-	2,95	3,20	-	26,0
27,0	-	-	-	-	-	2,65	2,90	-	27,0
28,0	-	-	-	-	-	-	2,65	-	28,0
29,0	-	-	-	-	-	-	2,40	-	29,0
30,0	-	-	-	-	-	-	2,20	-	30,0
31,0	-	-	-	-	-	-	1,95	-	31,0

Mode 1

Mode 2

RANGE GRAPH

QUADSTAR 1075



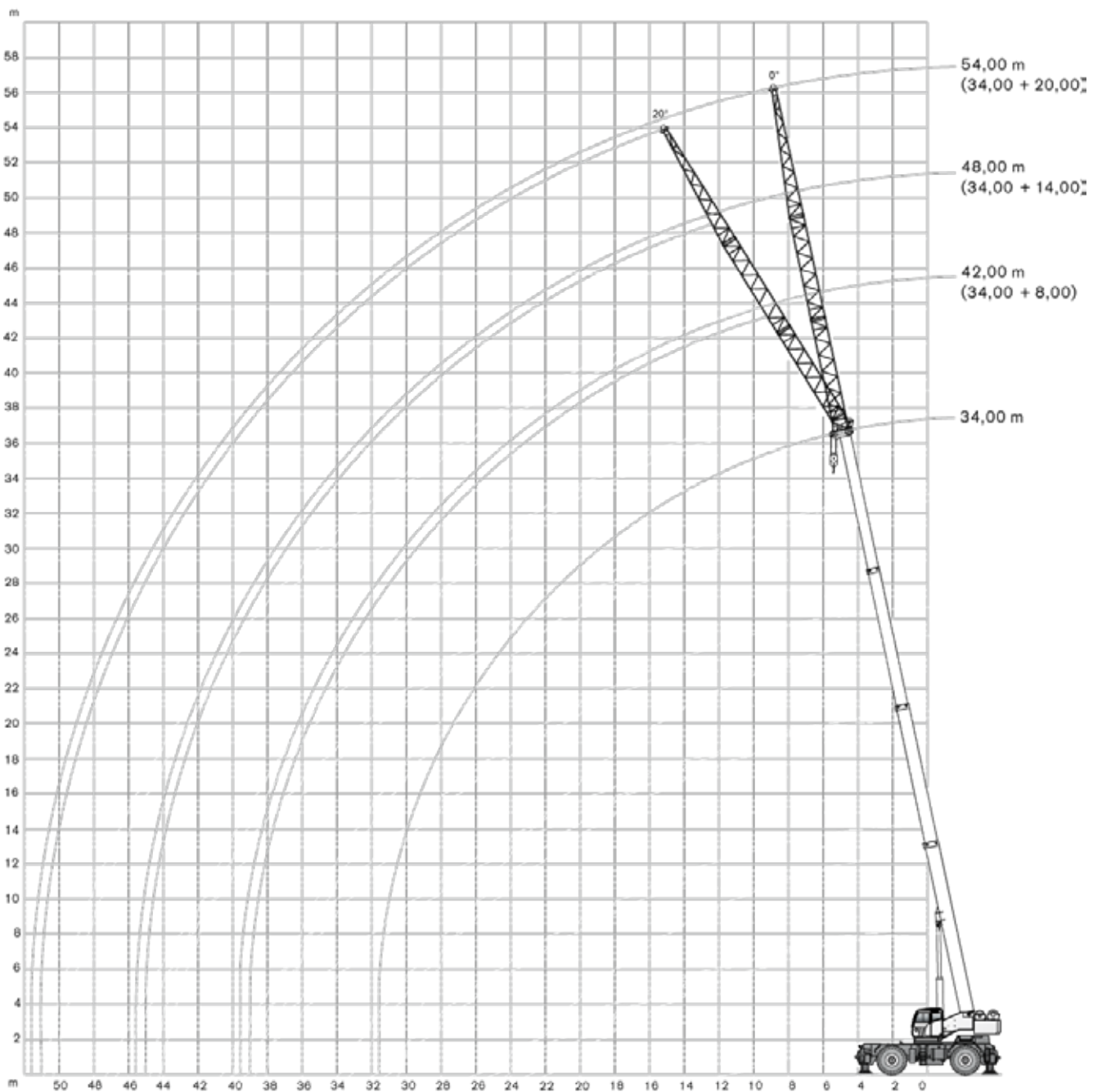
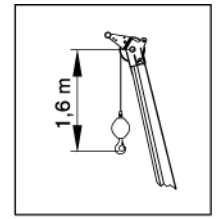
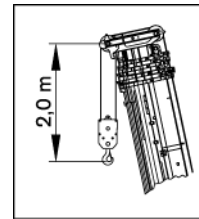







DIAGRAMME DE CHARGE · ARBEITSBEREICH · CAMPO DI PORTATA ·
 DIAGRAMA DE CARGA · GRÁFICO DE ALCANCE · ДИАГРАММА РАБОЧЕЙ ЗОНЫ



LOAD CHART

QUADSTAR 1075

GRAPHIQUE DE CHARGE · TRAGLASTTABELLE · DIAGRAMMA DI CARICO ·
TABLA DE CARGA · TABELA DE CARGA · ТАБЛИЦА НАГРУЗОК

		 8 t		 7,60 x 8,0 m		 360°		EUROPEAN STANDARD EN 13000		
 34.0 m										
		8 m			14 m			20 m		
		0°	20°		0°	20°		0°	20°	
m	t	t	t	t	t	t	t	t	m	
7,0	6,50	-	-	-	-	-	-	-	7,0	
8,0	6,50	-	-	3,30	-	-	-	-	8,0	
9,0	6,20	-	-	3,30	-	2,00	-	-	9,0	
10,0	5,90	3,20	-	3,30	-	2,00	-	-	10,0	
11,0	5,60	3,10	-	3,15	-	2,00	-	-	11,0	
12,0	5,30	3,00	-	3,00	-	2,00	-	-	12,0	
13,0	5,05	2,95	-	2,80	1,60	1,90	-	-	13,0	
14,0	4,80	2,90	-	2,70	1,60	1,80	-	-	14,0	
15,0	4,55	2,85	-	2,60	1,55	1,75	-	-	15,0	
16,0	4,30	2,80	-	2,50	1,50	1,60	0,90	-	16,0	
17,0	4,10	2,75	-	2,40	1,50	1,50	0,90	-	17,0	
18,0	3,90	2,70	-	2,30	1,45	1,45	0,85	-	18,0	
19,0	3,60	2,65	-	2,20	1,45	1,40	0,85	-	19,0	
20,0	3,30	2,60	-	2,10	1,40	1,35	0,80	-	20,0	
21,0	3,00	2,45	-	2,00	1,40	1,30	0,80	-	21,0	
22,0	2,75	2,30	-	1,90	1,35	1,25	0,80	-	22,0	
23,0	2,40	2,15	-	1,80	1,33	1,20	0,75	-	23,0	
24,0	2,05	2,05	-	1,75	1,30	1,15	0,75	-	24,0	
25,0	1,85	1,80	-	1,65	1,25	1,10	0,70	-	25,0	
26,0	1,65	1,60	-	1,60	1,20	1,10	0,70	-	26,0	
27,0	1,45	1,45	-	1,50	1,15	1,05	0,70	-	27,0	
28,0	1,30	1,30	-	1,40	1,10	1,00	0,70	-	28,0	
29,0	1,20	1,15	-	1,35	1,05	0,95	0,65	-	29,0	
30,0	1,10	1,00	-	1,30	1,00	0,90	0,65	-	30,0	
31,0	1,00	0,85	-	1,10	0,90	0,85	0,60	-	31,0	
32,0	0,90	0,70	-	0,90	0,85	0,80	0,60	-	32,0	
33,0	0,80	0,65	-	0,75	0,80	0,55	0,50	-	33,0	
34,0	0,75	0,60	-	0,70	0,75	0,50	0,45	-	34,0	
35,0	0,70	0,55	-	0,65	0,70	0,45	0,40	-	35,0	
36,0	0,70	0,50	-	0,60	0,65	0,40	0,35	-	36,0	
37,0	0,65	0,50	-	0,55	0,60	0,40	0,35	-	37,0	
38,0	0,60	0,50	-	0,50	0,55	0,35	0,30	-	38,0	
39,0	0,50	0,50	-	0,45	0,50	0,35	0,30	-	39,0	
40,0	-	-	-	0,40	0,45	0,30	0,25	-	40,0	
41,0	-	-	-	0,35	0,40	0,25	0,20	-	41,0	
42,0	-	-	-	0,30	0,30	0,20	0,20	-	42,0	
43,0	-	-	-	-	0,30	-	0,20	-	43,0	





TECHNICAL SPECIFICATIONS

QUADSTAR 1075

SPÉCIFICATIONS TECHNIQUES · TECHNISCHE DATEN · SPECIFICA TECNICA · ESPECIFICACIÓN TECNICA · ESPECIFICAÇÕES TÉCNICAS · ТЕХНИЧЕСКИЕ ХАРАКТЕРИСТИКИ







Boom

Flèche · Ausleger · Braccio · Pluma · Lança · Стрела

	4 sections · 4 segments · 4 Segmente · 4 sezioni · 4 secciones · 4 seções · 4 секции	
	Dual mode · Dual mode · Mode double · Dualmodus · Doppia modalità · Modo dual · Modo duplo · Два режима	
	Min. / Max. · Min / Max · Min. / Max. · Min. / Max. · Min. / Máx. · Min. / Máx. · Мин./Макс.	10.9 m / 34 m
	Max. main boom · Flèche principale max. · Hauptausleger, max. · Max. braccio principale · Máx. pluma principal · Máx. lança principal · Макс. главной стрелы	37 m
	Boom luffing angle range (min. / max.) · Plage angulaire de relevage de la flèche (min. / max.) · Winkelstellung des Auslegers (min. / max.) · Angolo di brandeggio (min. / max.) · Ángulos de elevación de la pluma (mín. / máx.) · Variação angular da articulação da lança (mín. / máx.) · Диапазон изменения угла вылета стрелы (мин./макс.)	-2° / +78°
	Boom raising / lowering time⁽¹⁾ · Durée de relevage / abaissement de la flèche ⁽¹⁾ · Ausleger Heben / Senken ⁽¹⁾ · Tempo di sollevamento / abbassamento braccio ⁽¹⁾ · Tiempo de elevación / descenso de la pluma ⁽¹⁾ · Tempo de elevação / abaixamento da lança ⁽¹⁾ · Время подъема/опускания стрелы ⁽¹⁾	80 s / 120 s
	Boom extension / retraction time⁽¹⁾ · Durée d'extension / rétraction de la flèche ⁽¹⁾ · Ausleger Ausfahren / Einfahren ⁽¹⁾ · Tempo di estensione / retrazione del braccio ⁽¹⁾ · Tiempo de extensión / retracción de la pluma ⁽¹⁾ · Tempo de alongamento / retração da lança ⁽¹⁾ · Время выдвижения/втягивания секций стрелы ⁽¹⁾	140 s / 130 s

Hoist

Treuil · Hubwerk · Argano e fune · Cabrestante · Guincho · Подъем

	Hydraulic motor · Moteur hydraulique · Hydromotor · Motore idraulico · Motor hidráulico · Motor hidráulicos · Гидравлический двигатель	
	Rope roller device · Tendeur de câble · Seilspannvorrichtung · Dispositivo pressafune · Sistema de tensado de cable · Sarrilho dos cabos · Направляющий ролик троса	
	Normally engaged brake · Frein serré normalement · Bremse im Normalzustand aktiviert · Freno normalmente inserito · Freno activado en estado normal · Freio normalmente aplicado · Нормально закрытый тормоз	
	2 speeds · 2 vitesses · 2 Geschwindigkeiten · 2 velocità · 2 velocidades · 2 velocidades · 2 скорости	
	Max.⁽¹⁾ · Max. ⁽¹⁾ · Max. ⁽¹⁾ · Max. ⁽¹⁾ · Máx. ⁽¹⁾ · Máx. ⁽¹⁾ · Макс. ⁽¹⁾	80 m/min.
	Rotational resistant · Faible torsion · Drehungsarm · Antirrotazione · Antirrotación · Anti-rotação · Антиротационный	
		18 mm
		220 m
	Permissible line pull · Traction du câble admissible · Max. Seilzug · Tiro massimo ammissibile · Tracción de cable admisible · Tração máxima admissível · Макс. нагр. на трос	63 kN



TECHNICAL SPECIFICATIONS

QUADSTAR 1075

SPÉCIFICATIONS TECHNIQUES · TECHNISCHE DATEN · SPECIFICA TECNICA · ESPECIFICACIÓN TECNICA · ESPECIFICAÇÕES TÉCNICAS · ТЕХНИЧЕСКИЕ ХАРАКТЕРИСТИКИ





Upper Structure

Tourelle · Oberwagen · Superestructura · Sovrastruttura · Estrutura superior · Верхняя надстройка

		8 t
	Non stop · Rotation libre · Unbegrenzt drehbar · Senza fine · Sin fin · Sem fim · Безостановочн Maximum speed⁽¹⁾ · Vitesse maximale ⁽¹⁾ · Max. Drehgeschwindigkeit ⁽¹⁾ · Velocità massima ⁽¹⁾ · Velocidad máxima ⁽¹⁾ · Velocidade máxima ⁽¹⁾ · Максимальная скорость ⁽¹⁾	360° 1.0 rpm
	Hydraulic motor · Moteur hydraulique · Hydromotor · Motore idraulico · Motor hidráulico · Motor hidráulico · Гидравлический двигатель Planetary reducer · Réducteur planétaire · Planetenuntersetzung · Riduttore epicicloidale · Reductor planetario · Redutor planetário · Планетарный редуктор	

Cab and Controls

Cabine et commandes · Kabine und Steuerung · Cabina e comandi · Cabina y controles ·
Cabine e controles · Кабина и органы управления

	S-space cab: Sliding door · Porte coulissante · Schiebetür · Porta scorrevole · Puerta deslizante · Porta corredeira · Раздвижная дверь Wide visibility · Visibilité optimale · Optimale Sichtverhältnisse · Ampia visibilità · Amplia visibilidad · Ampla visibilidade · Идеальный обзор Front and upper window with windscreen wiper · Essuie-glace pour pare-brise avant et lucarne de toit · Scheibenwischer für Frontscheibe und Dachfenster · Finestrino anteriore e superiore con tergicristalli · Luna frontal y superior con limpiaparabrisas · Janelas dianteira e superior com limpador de pára-brisa · Стеклоочистители переднего и верхнего окон Upper windows can be opened · Lucarne de toit ouvrante · Dachfenster zum Öffnen · Possibilità di apertura del finestrino superiore · Lunas superiores con apertura · A janela superior pode ser aberta · Открывающееся верхнее окно Tiltable cab · Cabine inclinable · Kabine neigbar · Cabina inclinabile · Cabina abatible · Cabine inclinável · Откидная кабина Fully adjustable seat onto shockproof suspensions · Siège à suspension pneumatique et entièrement réglable · Stoßgedämpfter Bedienerstz mit zahlreichen Einstellmöglich- keiten · Sedile interamente regolabile su sospensioni anti-shock · Asiento totalmente ajustable con suspensión anti-impacto · Assento totalmente ajustável com suspensões amortecidas · Полностью регулируемое сиденье на амортизирующей подвеске Equipped with tiltable arm rests with integrated hand controls for crane operation · Accoudoirs réglables avec éléments de commande intégrés pour le fonctionnement de la grue · Verstellbare Armlehnen mit integrierten Steuerelementen für den Kranbetrieb · Dotata di bracciolo inclinabile con comandi manuali integrati per il funzionamento della gru · Equipado con apoyabrazos abatible con controles integrados para operación de grúa · Equipado com apoio dos braços inclinável e controles de mão integrados para operação do guindaste · Откидные подлокотники с смонтированными в них пультами ручного управления краном Radio with CD player · Radio avec lecteur CD · Radio/CD · Autoradio con lettore CD · Radio-CD · Rádio com CD · Радиоприемник с плеером компакт-дисков в кабине Seat belts · Ceintures de sécurité · Sicherheitsgurte · Cinture di sicurezzas · Cinturones de seguridad · Cintos de segurança · Ремни безопасности
	Climatized cab · Klimatisierte Kabine · Cabine climatisée · Cabina climatizzata · Cabina climatizada · Cabine climatizada · Кабина с климат-контролем Air-conditioning · Climatisation · Klimaanlage · Aria condizionata · Climatización · Ar condicionado · Кондиционер
	Electro-proportional joysticks · Manipulateurs électro-proportionnels · Elektroproportionale Joysticks · Joystick elettro-proporzionali · Joystick electroproporcionados · Comandos eletroproporcionais · электропропорциональны й джойстик Load indicator with graphic interface · Indicateur de charge avec interface graphique · Lastanzeige mit grafischer Schnittstelle · Limitatore di carico con interfaccia grafica · Indicador de carga con interfaz gráfica · Indicador de carga com interface gráfica · Индикатор нагрузки с графическим интерфейсом
	Adjustable working light outside the cab · Einstellbarer Arbeitsscheinwerfer außen an Kabine · Phare de travail réglable à l'extérieur de la cabine · Faro di lavoro esterno alla cabina regolabile · Luz de trabajo ajustable en el exterior de la cabina · Farol de trabalho regulável fora da cabine · Регулируемое рабочее освещение снаружи кабины





TECHNICAL SPECIFICATIONS

QUADSTAR 1075

SPÉCIFICATIONS TECHNIQUES · TECHNISCHE DATEN · SPECIFICA TECNICA · ESPECIFICACIÓN TECNICA · ESPECIFICAÇÕES TÉCNICAS · ТЕХНИЧЕСКИЕ ХАРАКТЕРИСТИКИ

Carrier

Châssis · Unterwagen · Carro · Chasis · Chassi · Шасси

	Cummins QSB6.7 Stage IIIA - Tier 3 · Cummins QSB6.7 Stage IIIA - Tier 3 · Cummins QSB6.7 Stage IIIA - Tier 3 · Cummins QSB6.7 Stage IIIA - Tier 3 · Cummins QSB6.7 Stage IIIA - Tier 3 · Cummins QSB6.7 Stage IIIA - Tier 3 · Шестицилиндровый двигатель Cummins QSB6.7 Stage IIIA - Tier 3
	No. of cylinders · 6 Nombre de cylindres · Zahl der Zylinder · Numero di cilindri · N° cilindros · N° de cilindros · кол-во цилиндров
	Rated power · 164 kW @ 2200 1/min. Puissance nominale · Nennleistung · Potenza nominale · Potencia nominal · Potência nominal · Номинальная мощность
	Maximum gross torque · 945 Nm @ 1500 1/min. Couple de rotation max. · Max. Drehmoment · Coppia massima · Par de fuerza máx. · Torque bruto máx. · Макс. общий вращающий момент
	Fuel tank capacity · 300 l Capacité du réservoir de carburant · Kraftstofftankvolumen · Capacità serbatoio carburante · Volumen depósito combustible · Capacidade do tanque · Емкость топливного бака
	6 x 6 with torque converter · 6 x 6 avec convertisseur de couple · 6 x 6 mit Drehmomentwandler · 6 x 6 con convertitore di coppia · 6 x 6 con convertidor de par · 6 x 6 com conversor de torque · 6 x 6 с гидротрансформатором
	2 wheel drive in high range mode · 2 roues motrices en mode haute gamme · Zweiradantrieb in hoher Fahrstufe · 2 ruote motrici in modalità sbraccio elevato · Tracción a 2 ruedas en modo de velocidades largas · Tração em 2 rodas em alta velocidade · привод на 2 колеса в повышенном диапазоне
	4 wheel drive in low range mode · 4 roues motrices en mode basse gamme · Vierradantrieb in niedriger Fahrstufe · 4 ruote motrici in modalità sbraccio ridotto · Tracción a 4 ruedas en modo de velocidades cortas · Tração nas 4 rodas em baixa velocidade · привод на 4 колеса в низком диапазоне
	Front wheel steering · Roues avant directrices · Vorderachslenkung · Sterzataura a due ruote anteriori · Dirección en las ruedas delanteras · Manobra com as rodas dianteiras · Рулевое управление передними колесами
	Four wheel steering concentric · Direction toutes roues · Allradlenkung · Sterzataura a quattro ruote concentrica · Dirección en las cuatro ruedas, concéntrica · Manobras concéntricas com as quatro rodas · Режим рулевого управления четырьмя колесами в режиме «концентрический ход»
	Four wheel steering crab · Marche en crabe toutes roues · Hundegang · Sterzataura a quattro ruote a granchio · Dirección en las cuatro ruedas, modo cangrejo · Translação lateral com as quatro rodas · Режим рулевого управления четырьмя колесами в режиме «крабовый ход»
	Two piston pumps · Double pompe à piston · Zwei Kolbenpumpen · Due pompe a pistoni · Bombas de dos pistones · Duas bombas de pistão · Два поршневых насоса
	One gear pump · Simple pompe à engrènement · Einzel-Zahnradpumpe · Pompa a ingranaggi · Bomba de engranaje simple · Uma bomba de engranagens · Один насос привода
	24 V
	Rear axle differential lock · Blocage du différentiel de l'essieu arrière · Hinterachs-Differenzialsperre · Blocco differenziale assale posteriore · Bloqueo diferencial eje trasero · Bloqueio do diferencial do eixo traseiro · Блокировка дифференциала задней оси



TECHNICAL SPECIFICATIONS

QUADSTAR 1075

SPÉCIFICATIONS TECHNIQUES · TECHNISCHE DATEN · SPECIFICA TECNICA · ESPECIFICACIÓN TECNICA · ESPECIFICAÇÕES TÉCNICAS · ТЕХНИЧЕСКИЕ ХАРАКТЕРИСТИКИ

Vehicle Performance

Performances du véhicule · Fahrleistungen · Prestazioni veicolo · Prestaciones del vehículo · Desempenho do veículo · Характеристики автомобиля

	Max.⁽²⁾ · Max. ⁽²⁾ · Max. ⁽²⁾ · Max. ⁽²⁾ · Máx. ⁽²⁾ · Máx. ⁽²⁾ · Макс. ⁽²⁾	> 200 %
	Max.⁽²⁾ · Max. ⁽²⁾ · Max. ⁽²⁾ · Max. ⁽²⁾ · Máx. ⁽²⁾ · Máx. ⁽²⁾ · Макс. ⁽²⁾	29 km/h
	Min. / Max. · Min / Max · Min. / Max. · Min. / Max. · Min. / Máx. · Min. / Máx. · Мин. / Макс.	-20° / 45 °C





Tires

Pneumatiques · Bereifung · Pneumatici · Neumáticos · Pneus · Шины

	Earth moving style · Bande de roulement de type pour machine de terrassement · Grobes Profil, wie Erdbewegungsmaschinen · Per movimento terra · Para movimiento de tierra · Banda larga estilo terraplenagem · С широким протектором для движения по грунту	23.5 R25
---	---	----------

Options

Options · Optionen · Opzionali · Opciones · Opcionais · Дополнительные опции

	Single sheave · Poulie unique · Einzelne Seilrolle · Puleggia singola · Una polea · Roldana simples · Один концевой шкив	
	Lattice type, side stowable · Fléchette en treillis, escamotable sur le côté · Gittermast, seitlich verstaubar · Tralicciata, staffabile lateralmente · Tipo celosia, almacenable lateralmente · Jib treliçada, alojamento lateral · Доп. стрела решетчатая, укладываемая сбоку	8 m
	Lattice type, not side stowable · Fléchette en treillis, non escamotable sur le côté · Gittermast, nicht seitlich verstaut · Tralicciata, non riponibile lateralmente · Tipo celosia, sin almacenamiento lateral · Jib treliçada, sem alojamento na lateral · решетчатого типа, не складывается	14 m / 20 m
	Angular offsets · Déports angulaires · Abwinkelbar · Inclinazioni · Inclinación · Desvío angular · Угловое смещение	0° / 20°
	Light on the first section of the boom · Projecteur de travail réglable sur le premier segment de la flèche · Einstellbare Arbeitsleuchte am ersten Auslegersegment · Faro sulla prima sezione del braccio principale · Luz de trabajo orientable en la primera sección de la pluma · Farol de serviço ajustável na primeira seção da lança · Регулируемый прожектор на первой секции стрелы	
	Rotating beacon on the first section of the boom · Gyrophare sur le premier segment de la flèche · Rundumleuchte am ersten Auslegersegment · Lampeggiance sulla prima sezione del braccio principale · Luz giratoria en la primera sección de la pluma · Farol de alerta giratório na primeira seção da lança · Вращающийся маяк на первой секции стрелы	
	Light on superstructure frame · Projecteur de travail réglable sur le cadre de la tourelle · Einstellbare Arbeitsleuchte am Oberwagenrahmen · Faro su telaio sovrastruttura · Luz de trabajo regulable en el marco de la superestructura · Farol de trabalho regulável no quadro da superestrutura · Управляемый прожектор на раме надстройки	
	Hydraulic motor · Moteur hydraulique · Hydromotor · Motore idraulico · Motor hidráulico · Motor hidráulicos · Гидравлический двигатель	
	Rope roller device · Tendeur de câble · Seilspannvorrichtung · Dispositivo pressafune · Sistema de tensado de cable · Sarilho dos cabos · Направляющий ролик троса	
	Normally engaged brake · Frein serré normalement · Bremse im Normalzustand aktiviert · Freno normalmente inserito · Freno activado en estado normal · Freio normalmente aplicado · Нормально закрытый тормоз	

TECHNICAL SPECIFICATIONS

QUADSTAR 1075

SPÉCIFICATIONS TECHNIQUES · TECHNISCHE DATEN · SPECIFICA TECNICA · ESPECIFICACIÓN TECNICA · ESPECIFICAÇÕES TÉCNICAS · ТЕХНИЧЕСКИЕ ХАРАКТЕРИСТИКИ

	2 speeds · 2 vitesses · 2 Geschwindigkeiten · 2 velocità · 2 velocidades · 2 velocidades · 2 скорости	
	Max.⁽¹⁾ · Max. ⁽¹⁾ · Max. ⁽¹⁾ · Max. ⁽¹⁾ · Máx. ⁽¹⁾ · Máx. ⁽¹⁾ · Макс. ⁽¹⁾	80 m/min.
	Rotational resistant · Faible torsion · Drehungsarm · Antirotazione · Antirotación · Anti-rotação · Антиротационный	
		18 mm
		220 mm
	Permissible line pull · Traction du câble admissible · Max. Seilzug · Tiro massimo ammissibile · Tracción de cable admisible · Tração máxima admissível · Макс. нагр. на трос	63 kN
	Outrigger control from the ground · Commande des stabilisateurs depuis le sol · Steuerung der Abstützungen vom Boden · Comando a terra per stabilizzatori · Control externo de los apoyos estabilizadores · Controle dos estabilizadores a partir do solo · Управление опорами с земли	
	Cummins QSB6.7 Stage IIIB - Tier 4i · Cummins QSB6.7 Stage IIIB - Tier 4i · Cummins QSB6.7 Stage IIIB - Tier 4i · Cummins QSB6.7 Stage IIIB - Tier 4i · Cummins QSB6.7 Stage IIIB - Tier 4i · Cummins QSB6.7 Stage IIIB - Tier 4i · Шестицилиндровый двигатель Cummins QSB6.7 Stage IIIB	
	No. of cylinders · Nombre de cylindres · Zahl der Zylinder · Numero di cilindri · N° cilindros · N° de cilindros · кол-во цилиндров	6
	Rated power · Puissance nominale · Nennleistung · Potenza nominale · Potencia nominal · Potência nominal · Номинальная мощность	164 kW @ 2200 1/min.
	Maximum gross torque · Couple de rotation max. · Max. Drehmoment · Coppia massima · Par de fuerza máx. · Torque bruto máx. · Макс. общий вращающий момент	945 Nm @ 1500 1/min.
	Fuel tank capacity · Capacité du réservoir de carburant · Kraftstofftankvolumen · Capacità serbatoio carburante · Volumen depósito combustible · Capacidade do tanque · Емкость топливного бака	300 l
	Kit for engine pre-warming · Kit pour préchauffage du moteur · Motorvorwärmung, Kit · Kit pre-riscaldamento motore · Kit de precalentamiento del motor · Kit de pré-aquecimento do motor · Комплект предварительного прогрева двигателя	
	Earth moving style · Bande de roulement de type pour machine de terrassement · Grobes Profil, wie Erdbewegungsmaschinen · Per movimiento terra · Para movimiento de tierra · Banda larga estilo terraplenagem · С широким протектором для движения по грунту	26.5 R25
	Spare wheel · Roue de secours · Reserverad · Ruota di scorta · Rueda de repuesto · Estepe · Запасное колесо	23.5R25 / 26.5R25

Emergency engine stop ·

Arrêt d'urgence du moteur · Motor-Notausschalter · Arresto di emergenza motore · Parada de emergencia del motor · Parada de emergência do motor · Устройство аварийного останова двигателя

Spark arrestor on exhaust pipe muffler* ·

Pare-étincelle sur le silencieux d'échappement* · Funkenfänger am Auspuff* · Parascintille su silenziatore scarico* · Parachispas en el silenciador del tubo de escape* · Placa protetora contra fagulhas no silencioso do escapamento* · Искрогаситель на глушителе выхлопной трубы*

Anemometer ·

Anémomètre · Windmesser · Anemometro · Anemómetro · Anemômetro · Анемометр

Rear towing hook ·

Crochet de remorquage arrière · Anhängerkupplung hinten · Gancio di traino posteriore · Enganche de remolque · Gancho traseiro de reboque · Крюк задний, буксировочный

Wooden box for cab protection in sea shipment ·

Caisson en bois pour protéger la cabine en cas de transport par voie maritime · Holzverpackung zum Schutz der Kabine beim Seetransport · Cassa in legno per protezione cabina per spedizione marittima · Caja de madera para proteger la cabina para el transporte marítimo · Caixa de madeira para proteção da cabine em transporte marítimo · Деревянная обшивка кабины для транспортировки морем

Removable parts disassembling and put into wooden box tied to the crane ·

Démontage des composants amovibles pour les conserver dans des caisses de bois arrimées à la grue · Bewegliche Teile demontieren und in Holzverpackung am Kran verstauen · Smontaggio parti asportabili e sistemate in cassa in legno legata alla gru · Desmontaje de las piezas desmontables y colocación en caja de madera fijada a la grúa · Desmontagem de peças removíveis e colocação em caixa de madeira amarrada ao guindaste · Разборка съемных частей и укладка их в деревянный ящик, закрепленный к крану

Anti-corrosive protective waxing for sea shipping ·

Antikorrosions-Schutzwachsüberzug für Seetransport · Ceratura protettiva per spedizione marittima · Aplicación de cera de protección para el transporte marítimo · Cera protetora anticorrosiva para transporte marítimo · Нанесение антикоррозийного защитного покрытия для транспортировки морем

Special customer paint one colour on the whole crane ·

Peinture monochrome sur l'ensemble de la grue, sur demande du client · Lackierung nach Kundenwunsch, einfarbig, gesamter Kran · Verniciatura speciale 1 colore su autogrù intera · 1 color de pintura especial en toda la grúa · Pintura especial do cliente, uma cor em todo o guindaste · Покраска всего крана в цвет заказчика, один цвет

Special customer paint one colour only on the upper or lower part of the crane ·

Peinture monochrome uniquement sur la partie supérieure ou inférieure de la grue · Lackierung nach Kundenwunsch, einfarbig, Ober- oder Unterteil des Krans · Verniciatura speciale 1 colore solo parte superiore o inferiore della gru · 1 color de pintura especial sólo en parte superior o inferior de la grúa · Pintura especial do cliente, uma cor só nas partes superior ou inferior do guindaste · Покраска крана в цвет заказчика, один цвет, только верхняя или нижняя часть

Special customer paint two colours on the whole crane ·

Peinture bichrome sur l'ensemble de la grue, sur demande du client · Lackierung nach Kundenwunsch, zweifarbig, gesamter Kran · Verniciatura speciale 2 colori su autogrù intera · 2 colores de pintura especial en toda la grúa · Pintura especial do cliente, duas cores em todo o guindaste · Покраска всего крана в цвет заказчика, два цвета

Special customer paint of all boom elements ·

Peinture sur demande du client sur l'ensemble des éléments de flèche · Lackierung nach Kundenwunsch, sämtliche Auslegerbauteile · Verniciatura speciale su tutte le sezioni del braccio · Pintura especial en todas las secciones de la pluma · Pintura especial do cliente em todos os elementos da lança · Покраска всех секций стрелы крана в цвет заказчика

Special heavy painting suitable for corrosive environments ·









Peinture spéciale pour environnement hautement corrosifs · Sonderlackierung für korrosive Umgebung · Verniciatura speciale adatta ad ambienti corrosivi · Pintura especial para ambientes corrosivos · Pintura especial reforçada para ambientes corrosivos · Покраска специальной антикоррозийной краской

* only for engine Stage IIIA Tier 3 · uniquement pour moteur niveau IIIA Tier 3 · nur für Motoren gem. Stufe IIIA Tier 3 · solo per motore Stage IIIA Tier 3 · solo para motores Fase IIIA/Tier 3 · somente para motor Stage IIIA Tier 3 · только для двигателей стандарта IIIA Tier 3

TECHNICAL SPECIFICATIONS

QUADSTAR 1075

SPÉCIFICATIONS TECHNIQUES · TECHNISCHE DATEN · SPECIFICA TECNICA · ESPECIFICACIÓN TECNICA · ESPECIFICAÇÕES TÉCNICAS · ТЕХНИЧЕСКИЕ ХАРАКТЕРИСТИКИ

							Standard	Optional
							Standard	Optional
t			1	2			Standard	En option
							Serie	Option
							Standard	Opzionale
							Estándar	Opcional
							Padrão	Opcional
							Стандарт	Опция
75 t	6	12	•			•	•	
40 t	4	8	•			•		•
40 t	4	8	•		•			•
12.5 t	1	2	•	•		•		•
8 t	0	1	•	•		•		•

Note: refer to your local dealer for a full list of options.

(1) Indicative value only for reference.

(2) Standard crane in travelling configuration – value calculated with nominal tire radius and max power delivered to the wheels.

Remarque : Contactez votre concessionnaire pour obtenir la liste complète des options.

(1) Valeur indicative, pour référence uniquement.

(2) Grue standard en configuration de conduite – valeur calculée en fonction du rayon nominal du pneu et de la puissance max. transmise aux roues.

Hinweis: Ihr Händler vor Ort hält eine Übersicht aller verfügbarer Optionen bereit.

(1) Anhaltswert, dient nur als Referenz.

(2) Standardkran in verfahrbarer Konfiguration. Berechnung basiert auf Reifen-Nennradius und Maximalkraft, die auf die Räder wirkt.

Nota: Riferirsi al dealer di zona per un elenco completo degli opzionali.

(1) Valore indicativo solo come riferimento.

(2) Gru in versione standard ed in condizioni di marcia – valore calcolate in base al raggio nominale del pneumatico e alla massima possidenza alla ruota.

Nota: consulte la lista completa de opciones en su distribuidor local.

(1) Valor indicativo, sólo de referencia.

(2) Grúa estándar en configuración de marcha – valor calculado considerando el radio nominal del neumático y máxima potencia en las ruedas.

Nota: consulte no seu distribuidor local a relação completa de opcionais.

(1) Valor sugerido apenas para referência.

(2) Guindaste padrão em configuração de marcha – valor calculado considerando raio nominal dos pneus e potência máxima transmitida às rodas.

Примечание. Полный список всех доступных опций можно получить у местного дилера.

(1) Значения указаны только для справки.

(2) Значения даны для крана стандартной комплектации в режиме для перевозки и рассчитаны для шин нормального радиуса и максимального крутящего момента, передаваемого на колеса. крутящего момента, передаваемого на колеса.

NOTES TO LIFTING CAPACITY

QUADSTAR 1075

NOTES RELATIVES À LA CAPACITÉ DE LEVAGE · HINWEIS ZU TRAGFÄHIGKEITEN · ANNOTAZIONI SULLE PORTATE · NOTAS SOBRE LA CAPACIDAD DE ELEVACIÓN · NOTAS SOBRE A CAPACIDADE DE IÇAMENTO · ПРИМЕЧАНИЯ ПО ГРУЗОПОДЪЕМНОСТИ

Weight of hook blocks and slings is considered part of the load and must be subtracted from the capacity ratings. Consult operation manual for further details.

Note: Data published herein is intended as a guideline only and shall not be construed to warrant applicability for lifting purposes. For actual crane operation refer to the computer charts and the operating manual, both of which are supplied with the crane.

Le poids du crochet-moufle et les élingues sont considérés comme entiers à la charge et doivent être soustraits des capacités. Pour plus de détails se référer au manuel d'instructions.

Remarque : Les présentes données sont publiées uniquement à titre indicatif et ne constituent en aucun cas une garantie d'aptitude aux opérations de levage.

Pour le fonctionnement de la grue, consulter les graphiques et le manuel d'instructions, fournis tous les deux avec la grue.

Gewichte der Unterflaschen sowie der Aufnahmemittel sind Bestandteile der Last und sind von den Tragfähigkeiten abzuziehen. Weitere Informationen entnehmen Sie bitte dem Bedienerhandbuch.

Hinweis: Die hier aufgeführten Daten dienen lediglich als Richtlinie und dürfen nicht für Hubeinsätze herangezogen werden. Für den tatsächlichen Betrieb des Kranes sind die Computertabellen und das Bedienerhandbuch zu Rate zu ziehen, die mit dem Kran ausgeliefert werden.

Il peso dei bozzelli e delle funi di imbracaggio viene considerato parte del carico e deve quindi essere sottratto dalle portate nominali. Per ulteriori dettagli sulla velocità del vento, consultare il manuale di istruzione della gru.

Nota: I dati riportati in questo prospetto sono forniti esclusivamente a titolo indicativo, pertanto non sono da ritenersi impegnativi ai fini dell'applicazione della garanzia sulle portate di sollevamento.

Per l'uso della gru occorre rispettare le tabelle originali e il manuale d'uso forniti in dotazione con la gru stessa.

Los pesos de los ganchos y las eslingas se consideran parte de la carga y tienen que ser restados de las capacidades nominales. Consulte el manual de instrucciones para más detalles.

Nota: Los datos publicados se proporcionan a título informativo, por tanto, no se consideraran vinculantes a los efectos de la garantía de la capacidad de elevación.

Para operar la grúa deben cumplirse las tablas originales y el manual de instrucciones suministrados con la grúa.

O peso dos moitões e eslingas é considerado parte da carga e tem de ser subtraído das capacidades nominais. Consultar manual de operação para outros detalhes.

Nota: Os dados publicados aqui destinam-se a simples orientação e não devem ser interpretados como garantia de aplicabilidade para fins de içamento.

Para a operação efetiva do guindaste, consulte as tabelas de computador e o manual de operação, ambos fornecidos com o guindaste.

Вес крюкоблока и строп считается частью груза и должен вычитаться из номинальных значений грузоподъемности. Подробности см. в руководстве по эксплуатации.

Примечание. Публикуемые данные даются только для справки и не должны использоваться при расчете нагрузки.

Расчетные данные для использования при эксплуатации крана приводятся в компьютерных таблицах и в руководстве по эксплуатации, поставляемыми вместе с краном.

NOTES

QUADSTAR 1075

NOTES · NOTIZEN · NOTA · NOTAS · NOTAS ·
ПОМЕТЫ, КОММЕНТАРИИ, ПРИМЕЧАНИЯ

A large rectangular area consisting of 25 horizontal lines, intended for writing notes.

NOTES

QUADSTAR 1075

NOTES · NOTIZEN · NOTA · NOTAS · NOTAS ·
ПОМЕТА, КОММЕНТАРИИ, ПРИМЕЧАНИЯ

A large rectangular area with horizontal lines, intended for writing notes. The lines are evenly spaced and cover the majority of the page's width and height.

Effective Date: September 2015.

Product specifications and prices are subject to change without notice or obligation. The photographs and/or drawings in this document are for illustrative purposes only. Refer to the appropriate Operator's Manual for instructions on the proper use of this equipment. Failure to follow the appropriate Operator's Manual when using our equipment or to otherwise act irresponsibly may result in serious injury or death. The only warranty applicable to our equipment is the standard written warranty applicable to the particular product and sale and Terex makes no other warranty, express or implied. Products and services listed may be trademarks, service marks or trade-names of Terex Corporation and/or its subsidiaries in the USA and other countries. All rights are reserved. Terex® is a registered trademark of Terex Corporation in the USA and many other countries.

Gültig ab: September 2015.

Produktbeschreibungen und Preise können jederzeit und ohne Verpflichtung zur Ankündigung geändert werden. Die in diesem Dokument enthaltenen Fotos und/oder Zeichnungen dienen rein anschaulichen Zwecken. Anweisungen zur ordnungsgemäßen Verwendung dieser Ausrüstung entnehmen Sie bitte dem zugehörigen Betriebshandbuch. Nichtbefolgung des Betriebshandbuchs bei der Verwendung unserer Produkte oder anderweitig fahrlässiges Verhalten kann zu schwerwiegenden Verletzungen oder Tod führen. Für dieses Produkt wird ausschließlich die entsprechende, schriftlich niedergelegte Standardgarantie gewährt. Terex leistet keinerlei darüber hinaus gehende Garantie, weder ausdrücklich noch stillschweigend. Die Bezeichnungen der aufgeführten Produkte und Leistungen sind gegebenenfalls Marken, Servicemarken oder Handelsnamen der Terex Corporation und/oder ihrer Tochtergesellschaften in den USA und anderen Ländern. Alle Rechte vorbehalten. „TEREX“ ist eine eingetragene Marke der Terex Corporation in den USA und vielen anderen Ländern.

Date d'effet : Septembre 2015.

Les spécifications et prix des produits sont sujets à modification sans avis ou obligation. Les photographies et/ou dessins contenus dans ce documents sont uniquement pour illustration. Veuillez vous référer à la notice d'utilisation appropriée pour les instructions quant à l'utilisation correcte de cet équipement. Tout manquement au suivi de la notice d'utilisation appropriée lors de l'utilisation de notre équipement ou tout acte autrement irresponsable peut résulter en blessure corporelle sérieuse ou mortelle. La seule garantie applicable à notre équipement est la garantie standard écrite applicable à un produit et à une vente spécifique. Terex n'offre aucune autre garantie, expresse ou implicite. Les produits et services proposés peuvent être des marques de fabrique, des marques de service ou des appellations commerciales de Terex Corporation et/ou ses filiales aux Etats Unis et dans les autres pays, et tous les droits sont réservés. «TEREX» est une marque déposée de Terex Corporation aux Etats Unis et dans de nombreux autres pays.

Data di inizio validità: Settembre 2015.

Ci riserviamo il diritto di modificare le specifiche e i prezzi dei prodotti in ogni momento e senza preavviso. Le fotografie e/o i disegni contenuti in questo documento sono destinati unicamente a scopi illustrativi. Consultare le istruzioni sull'uso corretto di questo macchinario, contenute nell'opportuno Manuale dell'operatore. L'inottemperanza delle istruzioni contenute nel Manuale dell'operatore del macchinario e altri comportamenti irresponsabili possono provocare gravi lesioni, anche mortali. L'unica garanzia applicabile ai nostri macchinari è la garanzia scritta standard applicabile al particolare prodotto e alla particolare vendita; Terex è esonerata dal fornire qualsiasi altra garanzia, esplicita o implicita. I prodotti e servizi elencati possono essere dei marchi di fabbrica, marchi di servizio o nomi commerciali di TEREX Corporation e/o società affiliate negli Stati Uniti d'America e altre nazioni e tutti i diritti sono riservati. „TEREX“ è un marchio registrato di Terex Corporation negli USA e molti altri Paesi.

Fecha efectiva: Septiembre 2015.

Los precios y las especificaciones de productos pueden sufrir cambios sin aviso previo u obligación. Las fotografías o dibujos de este documento tienen un fin meramente ilustrativo. Consulte el manual de instrucciones del operador correspondiente para más información sobre el uso correcto de este equipo. El hecho de no respetar el manual del operador correspondiente al utilizar el equipo o actuar de forma irresponsable puede suponer lesiones graves o fatales. La única garantía aplicable a nuestro equipo es la garantía escrita estándar correspondiente a cada producto y venta, y TEREX no amplía dicha garantía de forma expresa o implícita. Los productos y servicios mencionados pueden ser marcas registradas, marcas de servicio o nombres de marca de TEREX Corporation o de sus filiales en Estados Unidos de América y otros países, y se reservan todos los derechos. „TEREX“ es una marca comercial registrada de Terex Corporation en Estados Unidos de América y muchos otros países.

Data de vigência: Setembro 2015.

Especificações e preços dos produtos sujeitos a alteração sem aviso prévio ou obrigações. As fotografias e/ou desenhos deste documento servem apenas para fins ilustrativos. Consulte o respectivo Manual de Instruções para instruções sobre o uso correto deste equipamento. A falta de atenção ao respectivo Manual do Operador no uso de nosso equipamento ou a operação da máquina em condições impróprias pode resultar em lesão grave ou morte. A única garantia aplicável aos nossos equipamentos é a garantia padrão por escrito, aplicável ao produto específico e à sua venda, sem que nenhuma outra, expressa ou implícita, seja oferecida pela Terex. Os produtos e serviços listados podem ser marcas comerciais, marcas de serviço ou nomes-fantasia da Terex Corporation e/ou suas subsidiárias nos EUA e em outros países. Todos os direitos reservados. Terex® é marca registrada da Terex Corporation nos EUA e muitos outros países.

Вступает в силу: Сентябрь 2015 г.

Технические характеристики и цены могут изменяться без предварительного уведомления и без каких-либо обязательств для производителя. Фотографии и (или) чертежи, использованные в документе, приведены исключительно в качестве иллюстраций. Инструкции по правилам эксплуатации даются в соответствующих руководствах для операторов данного оборудования. Невыполнение рекомендаций руководства по эксплуатации нашего оборудования или другие безответственные действия могут повлечь серьезные травмы или смерть. Единственной гарантией, действующей в отношении нашего оборудования, является стандартная форма письменной гарантии на данный тип оборудования и на условия его продажи.

Copyright Terex Cranes 2015

Terex Cranes, Global Marketing, Dinglerstraße 24, 66482 Zweibrücken, Germany
Tel. +49 (0) 6332 830, Email: info.cranes@terex.com, www.terexcranes.com



www.terex.com/cranes

Brochure Reference: TC-DS-M-E/F/G//S/P/R-Quadstar 1075-09/15



WORKS FOR YOU.™